



DATE: February 15, 2021

FROM: Wight & Company
2500 N. Frontage Road
Darien, IL 60561

SUBJECT: **ADDENDUM #1 TO THE BIDDING DOCUMENTS FOR:
TRANSITION BUILDING BUILD OUT**
COMMUNITY HIGH SCHOOL DISTRICT 99

4232 Venard Road
Downers Grove, IL 60516

This addendum forms a part of the Bidding Contract Documents, dated January 15, 2021. Bidders must acknowledge receipt of this Addendum in the space provided on the Bid Form.

Attached in this Addendum:

Question and Answer Log

BG1 BP#6 Plumbing revised Scope of Work
BG 1 BP#8 HVAC revised Scope of Work

BG 1 BP#1 Masonry revised Bid Form
BG 1 BP#2 General Trades revised Bid Form
BG 1 BP#3 Drywall and Framing revised Bid Form
BG 1 BP#4 Painting revised Bid Form
BG 1 BP#5 Flooring Bid Form
BG 1 BP#6 Plumbing revised Bid Form
BG 1 BP#7 Fire Suppression revised Bid Form
BG 1 BP#8 HVAC revised Bid Form
BG 1 BP#9 Electrical revised Bid Form
BG 1 BP#10 Acoustical Ceilings revised Bid Form

DRAWINGS

Architectural

AD2.01

- ADDED Keynote D17 A2.01
- ADDED Typical Slab-on-Grade Patch Detail 2
- ADDED Typical Housekeeping Pad Detail 3
- UPDATED Keynote 17
- UPDATED Keynote 18
- UPDATED wall tag

A5.00

- UPDATED batt insulation location in wall sections
- UPDATED description in wall sections

A10.00

- ADDED painting to metal vent pipe enclosure
- ADDED Keynote F2

Mechanical

M2.01A

- ADDED metal vent pipe enclosure
- ADDED Keynote 19
- ADDED dryer vent
- ADDED Pipe Penetration of Exterior Wall Above Grade Detail 3
- ADDED Pipe Enclosure Detail 2

END OF ADDENDUM



2500 North Frontage Road
Darien, IL 60561
630.969.7000
Fax 630.7370518
www.wightco.com

Project Name: CHSD 99 Transition Building Build Out

Project Number: 210028

Date: February 15, 2021

Bid Question/Answer Log No. 1

The following clarification information is provided in response to questions received in accordance with the bid documents for the following Bid Packages:

Bid Group: 1

Bid Packages: 1-2

#	Question	Date	Answers	Date By
1.	<p>2. The specs call for (1) 12 strand and (1) 25 pair going from the new IDF to the New MDF. It looks like both rooms are existing and no new cabling is needed. Please verify.</p> <p>3. Are we installing a rack in the IDF? If so, the spec calls for either a 2 post or 4 post rack. Please verify.</p>	2-5-21	<p>1. Low voltage structured cabling for new classrooms 6 and 7 is NEW to existing IDF per details. Provide new patch panel per drawings.</p> <p>2. No new IDF rack is required, reuse existing. Provide new patch panel per drawings.</p>	2-8-21 SJ
2.	Please verify that there is a space for the 100 amp breaker in MDP.	2-8-21	Existing single-phase loads on the main MDP 400 Amp service panel are noted to be relocated on the new panel RP-2 to create space for a new 100 Amp/3P breaker to feed new panel.	

3.	Since there is no BAS system, is the HVAC contractor responsible for local controls?	2-8-21	Yes. All temperature controls are to be by the HVAC contractor. Scope of Work will be REVISED to show this.	2-9-21 NS
4.	I contacted Correct Electric regarding Division 28 Manufacturer requirements (page 24 of 45) and was told they are not working on this project.	2-9-21	There is no access control or security scope in this phase of the project, so that paragraph of division 28 is not applicable.	2-9-21
5.	Do you know the brand of the existing Fire Alarm equipment at the Transition Building?	2-10-21	It is EST(Edwards) as existing. It is on sheet E6.01, also find the picture attached.	2-10-21
6.	Classrooms 114, 110, 100 for example and all other areas that are (white) with no finish label on sheet A10.00, are those getting any floor finish or base. I see the (3) shades of grey for the QTZ tile and I see (1) room for carpet but I am not sure if the rest of the non-labeled white rooms are in scope or not? (see attached)	2-10-21	Those rooms are not part of your scope as they are existing. But if you reference AD2.01 drawing you are responsible for removing, prep and installation of new quartz tile per note D14.	2-11-21 NS
6.	The Signage specifications reference matching existing signage. Can you send photos of the existing signage?	2-11-21		2-12-21 NS

7.	Can you please clarify if we are to use Procore or Submittal Exchange for this project?	2-12-21	Procore	2-12-21 NS
8.	<ul style="list-style-type: none"> A3.01 and E3.01 show different scope in Corridor C103. Which is correct? 	2-12-21	<ul style="list-style-type: none"> For lighting in corridor C103 on sheet E3.01 there are 4 Nos. F-1 type lights fixtures, occupancy sensor, keyed switch with LED indication, exit sign light, and emergency wall pack light. The quantity of F-1 type lights matches architecture drawings. Please follow electrical drawings for lighting controls, exit sign, emergency lighting, and circuiting. 	2-15-21 AT
9.	<ul style="list-style-type: none"> Spec 275313 – 4 says to match the existing manufacturer for clocks. What is the existing manufacturer? 	2-12-21	<ul style="list-style-type: none"> Existing clocks are “ITC” make. 	2-15-21 AT
10.	<ul style="list-style-type: none"> Spec 275123 is for intercom systems, but there does not appear to be any work for the intercom system shown. The speakers shown are indicated as part of the AV system. 	2-12-21	<ul style="list-style-type: none"> No new intercom system in the extension. The AV speakers in the new classrooms are standalone system per sheet E2.01 and detail on sheet E6.02. 	2-15-21 AT
11.	<ul style="list-style-type: none"> Spec 283100 says “The Fire Alarm scope shall be completed by the district’s servicing company under this project.” Who is the district’s servicing company? 	2-12-21	Esscoe	2-15-21 AT

12.	<ul style="list-style-type: none"> The sump pump controller is listed in the electrical scope. Typically this would be part of the plumbing scope, with electrical providing a power connection. Please confirm. 	2-12-21	The sump pump controller shall be furnished and installed by the Plumbing Contractor and power and final connections are by the Electrical Contractor.	2-15-21 NS
13.	<ul style="list-style-type: none"> Hand Dryers are indicated to be furnished and installed by electrical contractor per scope. Drawings indicate electrician are to install only. Please confirm intent. 	2-12-21	Electrical Contractor to Furnish and Install Electric Hand Dryers.	2-15-21 NS

BG1 BP06 SCOPE OF WORK FOR PLUMBING – TRANSITION BUILDING BUILD-OUT

Scope – This TRADE CONTRACTOR’s scope shall include but not be limited to the scope listed below. Please see entirety of bid documents for all scope requirements.

1. This TRADE CONTRACTOR shall reference ALL Drawings in this Bid Package as they relate to Architectural, Mechanical, Plumbing and Electrical. This TRADE CONTRACTOR shall read all Specification Sections in this manual as well as Notes and General Notes included in the drawings as they pertain to this scope of work. This TRADE CONTRACTOR shall review the project SCHEDULE (May 1st, 2021 through August 1th, 2021, with the possibility of getting underground plumbing installed week of 3-22-21) stated in this project manual and provide sufficient manpower and equipment to complete this TRADE CONTRACTOR’s scope of work within the designated durations provided.
2. This TRADE CONTRACTOR shall be responsible for furnishing and installing all materials, skilled and/or licensed labor, equipment, tools, etc... for a complete and operable Plumbing system including but not limited to all sanitary and storm/overflow piping, valves, drains, vents, equipment, fixtures, cleanouts, roof drains, overflow drains, traps, hangers, mixing valves, supports, hangers, elevator B pit pump, etc... as listed in the specifications and shown on the construction documents.

NOTE: This TRADE CONTRACTOR is responsible for all plumbing piping insulation, including reinsulating of exiting roof drains.

NOTE: This TRADE CONTRACTOR shall be responsible for Plumbing Demolition including removal and disposal as shown on PD2.01 including any existing plumbing insulation that is to be removed. All hangers supporting existing plumbing piping are also to be removed. Demolition Debris to be disposed in Wight Construction Supplied Dumpster. Please include quantity of dumpsters on bid form per All Scope item #28.

3. This TRADE CONTRACTOR shall be responsible for connecting to existing plumbing lines (ie sanitary, storm, CW/HW/HWR,, vents) as shown on the bidding documents. This Trade Contractor shall furnish and install all Plumbing piping, valves, check valves, etc.. for these tie-ins as listed in the specifications and shown on the construction documents.

NOTE: This TRADE CONTRACTOR responsible for protecting all adjacent areas.

4. This TRADE CONTRACTOR shall be responsible for all above grade rough and finish plumbing according to the drawings, specifications and contract documents including but not limited to all piping, vents, hangers, valves, wall hydrants, hose bibs, water hammer arrestor(s), funnel drains, roof drains, overflow drains, extension collars, roof hydrants, wall cleanouts, reduced pressure zone backflow preventers, sediment traps, etc... all work to be completed per applicable codes and standards.
5. All shutdowns and/or interruptions in plumbing system shall be coordinated through Construction Manager and scheduled to minimize any disruption to the school’s operations. Forty eight (48) hour notification must be provided to the Construction Manager of any shutdown or interruption that occurs even when facility is not in operation.
6. This TRADE CONTRACTOR shall be responsible for and compliant with all specified requirements including but not limited to all: Performance Requirements, Submittals, QA, Testing, Training, QC,

00300-1

and Extra Materials specified and pertaining to this trade contractor's work as noted in the plans and specifications.

Note: This TRADE CONTRACTOR's Guarantee/warranty period of equipment will not start until after final acceptance, including any and all equipment utilized before final acceptance. Targeted Substantial Completion Date of 8-1-21.

7. This TRADE CONTRACTOR shall be responsible for contacting jurisdictional inspection agencies (i.e. local code enforcement, testing agency's) associated with the work of this Trade Contractor to:
 - A) Schedule any and all required inspections so as not to delay project schedule,
 - B) Complete all work required for acceptance of this Trade Contractors work by the jurisdictional inspecting agency (at no additional cost, including incidentals) and
 - C) Submit all inspecting agency ruling related documentation/correspondence to Construction Manager before close of business the day of occurrence.
8. This TRADE CONTRACTOR shall provide all clip hangers, angles, and miscellaneous metal of any nature, which is required for work covered by this Contract.
9. This TRADE CONTRACTOR shall provide all sleeves and coring of walls, floors, etc., including caulking, packing of sleeves and openings as indicated on construction documents and/or as specified in the project manual. Contractor to protect all floor openings left in floors for passage of piping and other items. Any scanning of walls/existing concrete floors shall be included in this TRADE CONTRACTOR's scope of work.

NOTE: This TRADE CONTRACTOR shall be responsible for saw-cutting and removal of existing slab for installation of new under slab plumbing as shown on 1/P2.01 and AD2.01. Dumpsters to be supplied by THIS TRADE CONTRACTOR for removal of this concrete waste. This TRADE CONTRACTOR is also responsible for the pour back of concrete slab.

NOTE: This TRADE CONTRACTOR shall furnish and install ejector pit pump and all controls. Power and Final connections to be by the Electrical Trade Contractor.

10. This Trade Contractor shall be responsible to balance the HWR loop for areas that areas that are impacted by this scope of work.
11. This TRADE CONTRACTOR shall furnish and install all required piping identification, valve tagging, equipment tagging, and charts as per the specifications. Valve tags shall not be repeated anywhere in the building. A detailed schematic and list shall be provided and installed in the main mechanical room or in a location as selected by the owner.
12. This TRADE CONTRACTOR shall be responsible for fire stopping all thru wall penetrations in rated walls as indicated on construction documents and/or as specified in the project manual.

ALLOWANCES, BOND, & ALTERNATES

1. This TRADE CONTRACTOR shall include an allowance of **\$10,000.00 in their base bid** to account for any unforeseen conditions. Contract amounts will be adjusted by change order for amounts greater or less than the allowance. Allowance to be utilized only at the direction of Construction Manager.
2. This TRADE CONTRACTOR will be required to provide a Performance and Payment Bond for their work in accordance with 00201 of the General Conditions.

ACCEPTANCE

Accepted as listed above in addition to terms and conditions of the original construction documents on which the bid was based.

Company: Wight Construction Services, Inc.
2500 North Frontage Road
Darien, IL 60561

Signed: _____

Printed Name: _____

Position: _____

Date: _____

END OF SECTION 00300 –Scope

00300-3

BG1 BP08 SCOPE OF WORK FOR HVAC – TRANSITION BUILDING BUILD-OUT

Scope – This TRADE CONTRACTOR's scope shall include but not be limited to the scope listed below. Please see entirety of bid documents for all scope requirements.

1. This TRADE CONTRACTOR shall reference ALL Drawings as they relate to HVAC. This TRADE CONTRACTOR shall read all Specification Sections in this manual as well as Notes and General Notes included in the drawings as they pertain to this scope of work. This TRADE CONTRACTOR shall review the project SCHEDULE (May 1st, 2021 through August 1st, 2021) stated in this project manual and provide sufficient manpower and equipment to complete this TRADE CONTRACTOR's scope of work within the designated durations provided.
2. This TRADE CONTRACTOR shall be responsible for furnishing and installing all materials, skilled and/or licensed labor, equipment, tools, and coordination, etc... for a complete functioning Heating, Ventilation and Air Conditioning System including all related assemblies and systems. This trade contractor shall include all Gas Furnaces, Condensing Units (Including Pad), Electric Wall Heaters, Inline Duct Booster Fans, Exhaust Fans, Finned Tube Radiators, Diffusers, Grilles, Registers, Electric Duct Coils, piping, tubes, fittings, loops, valves, drain lines (D), flexible connections, all hangers/supports, identification, testing-adjusting-balancing, variable frequency drives, refrigerant piping, pumps, diffusers, grilles, ducts, duct lining, duct accessories, duct silencers, and joint sealants, and other specified requirements for a complete, conforming and operable system as shown/stated in the plans and specifications and delivered per the project schedule.

NOTE: THIS TRADE CONTRACTOR shall furnish, and Install all Mechanical Equipment and components shown on MM.0.01, MD2.01A, M2.01A, M2.02A, M3.01A, M5.01, M6.01, M6.02, ME1.0. including all associated notes.

NOTE: This TRADE CONTRACTOR is responsible for all Mechanical Demolition as shown on MD2.01A, including all hangers. Demolition Debris to be disposed in Wight Construction Supplied Dumpster. Please include quantity of dumpsters on bid form per All Scope item #28.

NOTE: Masonry Trade Contractor will be responsible for making new IWL opening including furnish and installing lintel. This TRADE CONTRACTOR shall provide layout for exact location of this Louver and will responsible for all caulking at this louver.

NOTE: This Trade Contractor shall be responsible for removal of all existing gas piping shown to be removed and installation of all new gas piping as shown.

NOTE: This Trade Contractor shall be responsible for Exterior ACCU and interior GFU concrete equipment pads.

NOTE: This Trade Contractor shall be responsible for the new dryer vent and pipe enclosure per ADD #1 drawing.

3. This TRADE CONTRACTOR is responsible for shop drawings, layout, and field layout of this Trade Contractor's work. This TRADE CONTRACTOR shall coordinate the installation of his work with plumbing, electrical, HVAC, technology, and Fire Protection and all other trades as required.

00300-1

NOTE: There will be no extra costs allowed to this TRADE CONTRACTOR for any field routing or modifications that may be required for piping/duct/conduit due to existing field conditions in existing building

NOTE: This TRADE CONTRACTOR responsible for all field coordination/routing associated with ductwork/piping/equipment installation in the existing school building areas.

4. ALL HVAC Insulation (Exterior and Interior) will be by this TRADE CONTRACTOR. There is not a separate bid package for Insulation in this bid group.
5. ~~BAS (Building Automation System) and rough-in for temperature control will be by OTHERS.~~ Instrumentation and Control for HVAC, Direct Digital Control for HVAC, Sequence of Operation for HVAC shall be the responsibility of ~~OTHERS~~ this trade contractor. This trade contractor shall be responsible for all local HVAC controls (No BAS system at the building).
6. This TRADE CONTRACTOR is responsible for relocation of all mechanical equipment to be re-used (if any). This includes disconnection, rigging, hoisting, staging, storing, protecting, and reinstallation as required per the Mechanical Drawings. Including Balancing and Startup procedures.
7. This TRADE CONTRACTOR shall remove and reinstall any existing Acoustical Ceiling Tile to install THIS TRADE CONTRACTORS scope of work
8. This TRADE CONTRACTOR shall be responsible for the installation of smoke detectors in duct work, smoke duct detectors supplied by ELECTRICAL CONTRACTOR. THIS TRADE CONTRACTOR shall coordinate the locations with ELECTRICAL CONTRACTOR. All work completed according to the drawings, specifications and contract documents.
9. This TRADE CONTRACTOR shall be responsible for furnishing and installing any vent piping that may be required for any equipment (HVAC related equipment) as listed in the specifications and shown on the construction documents.
10. This TRADE CONTRACTOR shall furnish and install all roof curbs, roof curb extensions, extensions, Gas Furnace Venting. Including all Structural modifications to existing decking to support new roof penetrations as detailed on M6.02. All Roof Patching will be done by the General Trades Contractor.
11. This TRADE CONTRACTOR shall install all condensate piping as necessary whether indicated or not. Where drawings do not indicate where to run the condensate drain to, this trade contractor shall seek approval of their proposed location from CONSTRUCTION MANAGER. THIS TRADE CONTRACTOR shall make every effort to install the condensate drain line without the use of a condensate pump. If a condensate pump is needed, this shall be provided. THIS TRADE CONTRACTOR shall provide a pump that does not require hardwiring from the electrician and simply plugs into a standard wall outlet.
12. This TRADE CONTRACTOR shall provide temporary protection of all HVAC equipment, ductwork, and piping during construction according to the specifications. This shall include but is not limited to sealing all open ends of ductwork at all times to prevent dirt and dust from entering this ductwork. This shall apply to ductwork being stored on site prior to installation as well as the ductwork after it is installed. Failure to adequately protect ductwork will result in THIS TRADE CONTRACTOR being back-charged for any duct cleaning that will be required. Where equipment needs to be installed prior to the

00300-2

building being “watertight” this trade contractor shall provide, install, maintain and subsequently remove protection for this equipment.

NOTE: This TRADE CONTRACTOR shall seal new ductwork airtight with new duct mastic at all existing Joint/Connections.

13. This TRADE CONTRACTOR shall furnish and install all required piping identification, valve tagging, equipment tagging, and charts as per the specifications. Valve tags shall not be repeated anywhere in the building. A detailed schematic and list shall be provided and installed in the main mechanical room or in a location as selected by the owner.
14. This TRADE CONTRACTOR shall include all testing and balancing of HVAC system as required in obtaining approval of architect, engineer, owner, inspection authorities and other agencies. Provide required out-of-sequence and/or additional testing and balancing of HVAC systems to permit expedited completion of partitions, ceilings and other work, including furnishing and installing additional valves as required to complete the balancing and testing of work according to the drawings, specifications and contract documents. This includes all existing systems that call out to be rebalanced.
15. This TRADE CONTRACTOR shall be responsible for and compliant with all specified requirements including but not limited to all: Performance Requirements, Submittals, QA, Testing, Training, QC, and Extra Materials specified and pertaining to this trade contractor’s work as noted in the plans and specifications.

Note: This TRADE CONTRACTOR’s Guarantee/warranty period of equipment will not start until after final acceptance, including any and all equipment utilized before final acceptance. Targeted Substantial Completion Date o 8/1/21.

16. This TRADE CONTRACTOR shall provide all sleeves and coring of walls, floors, etc., including caulking, and packing of sleeves and openings as indicated on construction documents and/or as specified in the project manual. Contractor to protect all floor openings left in floors for passage of piping and other items. Any scanning of walls/existing concrete floors shall be included in this TRADE CONTRACTOR’s scope of work.
17. This TRADE CONTRACTOR shall provide all clip hangers, angles, and miscellaneous metal of any nature, which is required for work covered by this Contract.
18. This TRADE CONTRACTOR responsible for all new piping tie-ins and ductwork tie-ins, including new valves, vents, drains that might be required for these tie-ins. This TRADE CONTRACTOR responsible for coordinating all work required to complete the tie-ins, including shutdown/draining of existing systems.
19. This TRADE CONTRACTOR shall coordinate all piping & ductwork to avoid conflicts with areas required for other trade contractor’s work (i.e., light fixtures, ceiling heights, FP Piping, FP Heads, etc...).

Note: Any piping or ductwork resulting in lower ceiling heights than indicated in the construction documents will need approval from the CONSTRUCTION MANAGER. This piping or ductwork may be reinstalled at higher elevations at the request of the CONSTRUCTION MANAGER.

20. This TRADE CONTRACTOR shall include all rigging, hoisting, cranes, lifts, etc. necessary to install ALL of the mechanical equipment, ductwork or piping. Any crane/lift/hoisting equipment for all mechanical equipment must be mobilized, set up, utilized, taken down and demobilized with approval of the Construction Manager.

Cribbing and protection of existing concrete, asphalt, roofing, and landscaping must be provided, and this TRADE CONTRACTOR will be responsible for any damages caused.

- 21. All shutdowns and/or interruptions in mechanical system shall be coordinated through Construction Manager and scheduled to minimize any disruption. Forty eight (48) hour notification must be provided to the Construction Manager of any shutdown or interruption that occurs even when facility is not in operation.
- 22. This TRADE CONTRACTOR to identify in bid proposal lead times for all major pieces of equipment.

ALLOWANCES, BOND, & ALTERNATES

- 1. This TRADE CONTRACTOR **shall include an allowance of \$15,000.00 in their base bid** to account for any unforeseen conditions with HVAC Scope of Work. Contract amounts will be adjusted by change order for amounts greater or less than the allowance. Allowance to be utilized only at the direction of Construction Manager.
- 2. This TRADE CONTRACTOR will be required to provide a Performance and Payment Bond for their work in accordance with 00201 of the General Conditions.

ACCEPTANCE

Accepted as listed above in addition to terms and conditions of the original construction documents on which the bid was based.

Company: Wight Construction Services, Inc.
2500 North Frontage Road
Darien, IL 60561

Signed: _____

Printed Name: _____

Position: _____

Date: _____

END OF SECTION 00300 –Scope

BID DATE: February 18th at 10:00 a.m. (CST)
(via Building Connected)

BID TO: Community High School District 99
Administrative Center
6301 Springside Avenue
Downers Grove, IL 60516

RECEIVED BY:

BID FROM: _____

BID FOR: Bid Group 1 - Bid Package #01-Masonry
Transition Building
4232 Venard Road
Downers Grove, IL 60516

THE UNDERSIGNED:

Acknowledges receipt of:

Plans and specifications for the work indicated above.

Addenda: No. _____ dated _____
No. _____ dated _____
No. _____ dated _____
No. _____ dated _____

Having examined the site of the work, and having familiarized himself or herself with local conditions affecting the cost of the work and with all requirements of the bidding documents including Instructions to Bidders, drawings, specifications and duly issued addenda as prepared by the architect, Wight & Company, hereby agrees to perform all work and furnish all labor, material and equipment specifically required of him by the bidding documents and such additional work as may be included as related requirements in other divisions or sections of the specifications, exclusive of alternate bids.

Agrees:

To furnish and install the described material and/or services for stated lump sum price.

To hold this bid open until **90** calendar days after bid opening date.

To accept the provisions of the General Provisions (Project Manual Division 0 – Bidding & Contracting Requirements

Section 00201) and disposition of bid security.

To enter into and execute a contract with the Owner, if awarded on the basis of this bid, and in connection therewith to:

1. Furnish all bonds and insurance required by the bidding documents.
2. Accomplish the work in accordance with the contract.
3. Complete the work within the contract time herein specified.

Completion Time:

The undersigned agrees to begin construction immediately, or as directed by the Construction Manager, upon notice of contract award and to perform the following components of the work in accordance with the Construction Manager's Construction. This schedule is bound in the Project Manual. See attached scope of work in section 0300.

SCOPE OF WORK:

The work in this agreement (without additional compensation) shall include, but shall not necessarily be limited to, all skilled labor, supervision, premium time, materials, tools, equipment, plant, supplies, samples, shop drawings, design/engineering drawings, layout, transportation, supervision, contributions, insurance, taxes (if applicable), compliance with all agencies (City / Village, County, State, Federal and/or any other jurisdictional agency, as may be required) and/or all services and facilities necessary and/or required for the performance of all Work shown, detailed, and/or implied by the following documents and as defined herein.

It is understood that this Trade Contractor shall perform the Work for a complete and operational system as indicated or implied in all Contract Documents. It is recognized and understood that the documents upon which the bid is based are at a conceptual phase and this Contractor who has certain skills and judgments based upon his knowledge of techniques, procedures, systems, general state of the art of his specialty is expected to include in the scope of work, all items required in order to carry out a complete and functional system whether or not shown or described in the contract documents. This contract will be awarded on the basis of such documents with the understanding that this contractor is to furnish and install all items required for the proper completion of this work without adjustment to this contract price. No extra payments shall be made of claims entertained as a result of such items, unless it can be clearly demonstrated to be added scope to the contract and beyond the original intent of the documents.

Contractor to provide all Trade Contract work referenced in:

1. Any sheet of this bid group package including (reference Division 0 – Bidding and Contract Requirements, Section 00200 – Notice to Bidders).
2. Specification 00300 Bid Packages Scope Document.

WORK BASE BID: For providing all work including all allowances as required for the completion of the construction of the base bid project as shown on the drawings and specifications and NOT including alternate bids and/or contractor's proposed alternates and substitutes.

BASE BID

TOTAL BASE BID AMOUNT **2021 TRANSITION BUILDING BUILD OUT:**

_____ Dollars (\$ _____)

BONDS:

This TRADE CONTRACTOR will be required to provide a Performance and Payment Bond for their work in accordance with 00201 of the General Conditions.

Award Basis:

The project will be awarded based upon the attached Evaluation Criteria, Section 301a. Owner and Construction Manager alternate's may be considered to find the most qualified bidder if the result of combining the base bid and the selected alternate(s) is the most qualified bid, and is to the benefit of the owner.

Each of the following amounts for alternate construction includes the entire cost of such construction, except as otherwise noted. Acceptance of any or all of the alternates for inclusion in the contract is the sole prerogative of the owner.

All additional costs due to the alternates are included in the amount to be added to the base bid, so that no additional costs will be borne by the owner due to acceptance of alternates. This alternate price is not to be included in the base bid price.

Owner Requested Alternates:

Each of the following amounts for alternate construction includes the entire cost of such construction, except as otherwise noted. Acceptance of any or all of the alternates for inclusion in the contract is the sole prerogative of the owner.

All additional costs due to the alternates are included in the amount to be added to the base bid, so that no additional costs will be borne by the owner due to acceptance of alternates.

Proposed Alternates: (Contractors Proposed Alternates)

Item Specified	Proposed Alternate	Change in Bid Price
1. _____	_____	_____
2. _____	_____	_____
3. _____	_____	_____

Owner Requested Unit Prices/Allowances (as applicable to this Trade Contractor's scope of work) (additive or deductive).

This trade contractor includes _____ dumpsters for all refuse caused by this trade contractor's work in the amount of _____ Dollars (\$_____) Note: trade contractors are to include in their bid form submittal the quantity of dumpsters required to complete their work and the cost associated with same. Dumpster costs will be subtracted by change order. Dumpsters will be procured and managed by Construction Manager. Note: Dumpster use in excess of that proposed by this Trade Contractor will be adjusted by back charge.

Owner Requested Scheduling Information:

Note: The work of this Trade Contractor is to be completed in accordance with the overall project schedule as identified elsewhere in this project manual and/or as subsequently directed by Construction Manager. This Trade Contractor shall submit a proposed submittals list/schedule/material log within five (5) calendar days of Notice To Proceed.

1. Shop drawings / Submittal for this trade contractor will be submitted within 10 calendar days of receipt of notice to proceed.

Bid Acceptance:

If written notice of the acceptance of this bid is mailed, telegraphed or delivered to the undersigned within the time noted herein, after the date of opening of bids or at any time thereafter before this bid is withdrawn, the undersigned agrees that he will execute a construction contract in accordance with the bids as accepted.

The Owner reserves the right to award the contract to its best interests, review and accept any and all value engineering alternatives, negotiate with the lowest responsible bidder, to reject any or all bids, to waive any informalities in bidding and to hold all bids for the bid guarantee period. The Owner reserves the right to award separate contracts for any of the items of work bid herein.

Bid Deposit:

The undersigned furnishes herewith, as required in the Instructions to Bidders, a bid deposit in the amount of ten percent (10%) of the amount bid in the form of Cashier's Check, or Certified Check, made payable to the Owner or Bid Bond, naming the Owner as obligee. (Bidder to check form of deposit furnished.)

It is understood and agreed that should the undersigned fail to enter into a contract with the Owner or furnish acceptable contract security within the time and in the manner herein provided, the bid deposit shall be retained by the Owner as liquidated damages and not as a forfeiture. As it is impossible to determine precisely an exact amount of damages the Owner will sustain, it is agreed that the bid deposit is a fair and equitable estimate of such damages.

REPRESENTATIONS AND CERTIFICATIONS:

The bidder makes the following representations and certifications as part of his bid on the project herein identified in the Bid Form. In the case of a joint venture bid, each party represents and certifies as to his own organization.

AVAILABILITY. The number and amount of contracts and awards pending which I am and/or will be obligated to perform, now and during the course of the project, will not interfere with or hinder the timely prosecution of my work.

SURETY. I have notified a Surety Company that I am submitting a bid for work to be performed on the project. The Surety Company has agreed to issue a performance and labor and material payment bond for my work, if my bid is accepted and the contract awarded to me.

INDEPENDENT PRICE DETERMINATION. The contract sum in this bid has been arrived at independently, without consultation, communication or agreement for the purpose of restricting competition.

PREVAILING WAGE. The contractor and each subcontractor shall pay not less than the general prevailing rate of hourly wages for work of a similar character in the locality in which the work is performed and not less than general prevailing rate of hourly wages for legal holidays and overtime work in the performance of work under this contract, as established by the Illinois Department of Labor, pursuant to an act of the General Assembly of the State of Illinois approved June 26, 1941 as amended according to Section 820 ILCS 130/1.

Pursuant to Section 820 ILCS 130/5, the contractor and each subcontractor shall keep an accurate record showing the names and occupation of all laborers, workers and mechanics employed by them, and also showing the actual hourly wages paid to each such individual, which record shall be open at all reasonable hours to inspection by the Owner, its officers and agents, and to agents of the Illinois Department of Labor.

The contractor and each subcontractor hereby agree, jointly and severally, to defend, indemnify and hold harmless the Owner from any and all claims, demands, liens or suits of any kind or nature whatsoever (including suits for injunctive relief) by the Illinois Department of Labor under the Illinois Prevailing Wage Act, Section 820 ILCS 130/1., or by any laborer, worker or mechanic employed by the contractor or the subcontractor who alleges that he has been paid for his services in a sum less than prevailing wage rates required by Illinois law. The Owner agrees to notify the contractor or subcontractor of the pendency of any such claim, demand, lien or suit.

By submitting a bid, each bidder agrees to waive any claim it has or may have against the Owner, the Architect, Engineer, Construction Manager and their respective employees, arising out of or in connection with the administration, evaluation, or recommendation of any bid; waiver of any requirements under the Bid Documents; or the Contract Document; acceptance or rejection of any bids; and award of the Contract.

Signature:

Respectfully submitted this _____ day _____, 2021

Type of Firm (Bidder to indicate)

_____ Individual

_____ Partnership

_____ Corporation

_____ Joint Venture

_____ Other

(CORPORATE SEAL)

(Firm Name)

(Address)

(Telephone Number)

(FAX)

(E-mail Address)

(Bidder's Signature)

(Title)

Subscribed and sworn to me
this . day of __, 2020

NOTE: All pages of this bid form must be returned with your proposal. Failure to do so shall disqualify your bid.

CERTIFICATE OF BIDDER ELIGIBILITY

720 ILCS 5/33E-11 REQUIRES THAT ALL CONTRACTORS BIDDING FOR PUBLIC AGENCIES IN THE State of Illinois certify that they are not barred from bidding on public contracts for bid rigging or bid rotation.

The following certification must be signed and submitted with bidder's bid proposal. FAILURE TO DO SO MAY RESULT IN DISQUALIFICATION OF THE BIDDER.

_____, as part of its bid for the _____ work for Community High School District 99, Downers Grove, Illinois, DuPage County, Illinois certified that said contractor is not barred from bidding on the aforementioned contract as a result of violation of either 720 ILCS 5/33E-3 or 720 ILCS 5/33-E4.

Firm: _____

By: _____
(Signature)

(Printed Name & Title)

SUBSCRIBED AND SWORN TO before me

This _____ day of _____, 202

NOTARY PUBLIC

**CRIMINAL CODE CERTIFICATION
AS REQUIRED BY:
STATE OF ILLINOIS CRIMINAL CODE OF 2012, 720 ILCS 5/33E-11**

I, _____ the individual whose signature appears below on this bid/contract
for _____ hereby certify that the bidding party/contracting party
is not barred from bidding on the contract as a result of a violation of either Section 33E-3 or Section 33E-4 of 720 ILCS 5/33E-
3 or 5/33E-4 of the Illinois Compiled Statutes, as amended.

By: _____
Authorized Agent of Contractor (name and title)

SUBSCRIBED AND SWORN to before
me this ____ day _____, 20__.

Notary Public

EQUAL EMPLOYMENT OPPORTUNITY

Section I. This EQUAL EMPLOYMENT OPPORTUNITY CLAUSE is required by the Illinois Human Rights Act and the Rules and Regulations of the Illinois Department of Human Rights published at 44 Illinois Administrative Code Section 750, *et seq.*

Section II. In the event of the Contractor's noncompliance with any provision of this Equal Employment Opportunity Clause, the Illinois Human Rights Act, or the Rules and Regulations of the Department of Human Rights (hereinafter referred to as the Department) the Contractor may be declared ineligible for future contracts or subcontracts with the State of Illinois or any of its political subdivisions or municipal corporations, and this Contract may be canceled or voided in whole or in part, and other sanctions or penalties may be imposed or remedies involved as provided by statute or regulation.

During the performance of this Agreement, the Contractor agrees:

A. That it will not discriminate against any employee or applicant for employment because of race, color, religion, sex, sexual orientation, national origin or ancestry, citizenship status, age, physical or mental disability unrelated to ability, military status or an unfavorable discharge from military service; and further that it will examine all job classifications to determine if minority persons or women are underutilized and will take appropriate affirmative action to rectify any such underutilization.

B. That, if it hires additional employees in order to perform this Contract, or any portion hereof, it will determine the availability (in accordance with the Department's Rules and Regulations) of minorities and women in the area(s) from which it may reasonably recruit and it will hire for each job classification for which employees are hired in such a way that minorities and women are not underutilized.

C. That, in all solicitations or advertisements for employees placed by it or on its behalf, it will state that all applicants will be afforded equal opportunity without discrimination because of race, color, religion, sex, sexual orientation, marital status, national origin or ancestry, citizenship status, age, or physical or mental handicap unrelated to ability, military status or an unfavorable discharge from military service.

D. That it will send to each labor organization or representative of workers with which it has or is bound by a collective bargaining or other agreement or understanding, a notice advising such labor organization or representative of the Vendor's obligations under the Illinois Human Rights Act and Department's Rules and Regulations. If any labor organization or representative fails or refuses to cooperate with the Contractor in its efforts to comply with the Act and Rules and Regulations, the Contractor will promptly notify the Department and the contracting agency and will recruit employees from other sources when necessary to fulfill its obligations under the Contract.

E. That it will submit reports as required by the Department's Rules and Regulations, furnish all relevant information as may from time to time be requested by the Department or the contracting agency, and in all respects comply with the Illinois Human Rights Act and Department's Rules and Regulations.

F. That it will permit access to all relevant books, records, accounts and work sites by personnel of the contracting agency and Department for purposes of investigation to ascertain compliance with the Illinois Human Rights Act and Department's Rules and Regulations.

G. That it will include verbatim or by reference the provisions of this Equal Employment Opportunity Clause in every subcontract it awards under which any portion of this Contract obligations are undertaken or assumed, so that such provisions will be binding upon such subcontractor. In the same manner as the other provisions of this Agreement, the Contractor will be liable for compliance with applicable provisions of this clause by such subcontractors; and further it will promptly notify the contracting agency and the Department in the event any subcontractor fails or refuses to comply therewith. In addition, the Contractor will not utilize any subcontractor declared by the Illinois Human Rights Department to be ineligible for contracts or subcontracts with the State of Illinois or any of its political subdivisions or municipal corporations.

ACKNOWLEDGED AND AGREED TO:

By: _____
Authorized Agent of Contractor (name and title)

DATE: _____

SEXUAL HARASSMENT POLICY

_____, having submitted a bid for _____ (Name of Contractor)
_____ to Community High School District No. 00, hereby certifies that
said contractor has a written sexual harassment policy in place in full compliance with 775 ILCS 5/2-105 (A) (4).

By: _____
Authorized Agent of Contractor (name and title)

SUBSCRIBED AND SWORN to before
me this ____ day _____, 20__.

Notary Public

TAX CERTIFICATION

I, _____, having been first duly sworn depose and state as follows:

I, _____, am the duly authorized agent for
High School District No. 99 for

_____ and I hereby certify that _____ is not delinquent in the payment of any tax administered by the Illinois Department of Revenue, or if it is:

a. it is contesting its liability for the tax or the amount of tax in accordance with procedures established by the appropriate Revenue Act; or

b. it has entered into an agreement with the Department of Revenue for payment of all taxes due and is currently in compliance with that agreement.

By: _____
Authorized Agent of Contractor (name and title)

SUBSCRIBED AND SWORN to before
me this ____ day _____, 20__.

Notary Public

SUBSTANCE ABUSE PREVENTION ON PUBLIC WORKS PROJECTS

The Contractor certifies that it has in place a written program that meets or exceeds the program requirements of the Substance Abuse Prevention on Public Works Projects Act (Public Act 95-0635), and will provide a copy thereof to Community High School District No. 99 prior to commencement of work on the Project.

By: _____
Authorized Agent of Contractor (name and title)

SUBSCRIBED AND SWORN to before
me this ____ day _____, 20__.

Notary Public

**CERTIFICATE REGARDING
EMPLOYMENT OF ILLINOIS WORKERS ON PUBLIC WORKS**

_____ agrees if at the time the Agreement is executed, or if during the term of the Agreement, there is excessive unemployment in Illinois as defined in the Employment of Illinois Workers on Public Works Act, 30- ILCS 570/0/01 et seq., as two consecutive months of unemployment exceeding 5%, then _____ agrees to employ Illinois laborers in accordance with the Employment of Illinois Workers on Public Works Act. An "Illinois laborer" is defined as any person who has resided in Illinois for at least thirty (30) days and intends to become or remain an Illinois resident.

Firm: _____

By: _____
(Signature)

(Printed Name & Title)

SUBSCRIBED AND SWORN TO before me

This _____ day of _____, 2021

NOTARY PUBLIC

PREVAILING WAGE AFFIDAVIT

AFFIDAVIT: "I (we) hereby certify and affirm that if awarded a contract with Community High School District 99, we will comply fully with the "Illinois Prevailing Wage Act (Ill. Rev. Stat., 1987 Ch. 48, Sections 398 s-1-12 as amended by Public Act 86-693 and 86-799 effected January 1, 1990, and any other amendments effective thereafter)". We further understand that current prevailing wage standards are included in the Supplementary General Conditions.

The following affidavit must be signed and submitted with bidder's bid proposal. FAILURE TO DO SO MAY RESULT IN DISQUALIFICATION OF THE BIDDER.

_____, as part of its bid for the _____ work for Community High School District 99, Downers Grove, Illinois, certifies that said contractor is not barred from bidding on the aforementioned contract as a result of a violation of the Illinois Prevailing Wage Act (Ill. Rev. Stat., 1987 Ch. 48, Sections 398 s-1-12 as amended by Public Act 86-693 and 86-799 effected January 1, 1990).

Firm: _____

By: _____

(Signature)

(Printed Name & Title)

SUBSCRIBED AND SWORN TO before me

This _____ day of _____, 2021

NOTARY PUBLIC

NON-COLLUSION AFFIDAVIT

AFFIDAVIT: "I (we) hereby certify and affirm that my (our) proposal was prepared independently for this project and that it contains no fees or amounts other than that for the legitimate execution of this work as specified and that it includes no understanding or agreements in restraint of trade."

The following affidavit must be signed and submitted with bidder's bid proposal.
FAILURE TO DO SO MAY RESULT IN DISQUALIFICATION OF THE BIDDER.

_____, as a part of its bid for the _____ work for Community High School District 99, Downers Grove, Illinois, certifies that said Contractor is not barred from bidding on the aforementioned contract as a result of a violation of the above Non-Collusion Affidavit.

Firm: _____

By: _____
(Signature)

(Printed Name & Title)

SUBSCRIBED AND SWORN TO before me

This _____ day of _____, 2021

NOTARY PUBLIC

Criminal Background Investigations

Contractor hereby represents, warrants and certified that no officer or director thereof has any knowledge that any employee thereof has been convicted of committing or attempting to commit "Criminal Code of 1961," 720 ILCS, Sections 5/11-6 (Indecent solicitation of a child), 5/11-9 (Public indecency), 5/11-14 (Prostitution), 5/11-15 (Soliciting for a prostitute), 5/11-15.1 (Soliciting for a juvenile prostitute), 5/11-19 (Pimping), 5/11-19.1 (Juvenile pimping), 5/11-19.2 (Exploitation of a child), 5/11-20 (Obscenity), 5/11-20.1 (Sexual assault), 5/12-14 (Aggravated criminal sexual assault), 5/12-15 (Criminal sexual abuse), and 5/120-16 (Aggravated criminal sexual abuse), and/or those offenses defined in the "Cannabis Control Act," 720 ILCS, 550/1 et seq. (except the "Illinois Controlled Substances Act," 720 ILCS 570/100 et seq. and/or any offense committed or attempted in any other state or against the laws of the United States, which if committed or attempted in this State, would have been punishable as one or more of the foregoing offenses.

Contractor further agrees that it shall not employ any person who have or may have direct, daily contact with the pupils of any school in the district, and for whom a criminal background investigation has not been conducted pursuant hereto, and further represents and agrees that all applicants for any such employment shall furnish with their applications the attached written "Authorization for Criminal Background Information" form authorizing the Board of Education to request a criminal background investigation of said applicant pursuant to Section 5/10-21.9 of the School Code of Illinois and to receive criminal history record information pursuant thereto to determine if the applicant has been convicted of committing or attempting to commit any of the criminal or drug offenses enumerated above. Contractor further agrees to submit with said authorization payment for any costs and expenses associated with the criminal background investigation.

Contractor further represents, warrants, and certifies that no applicant for employment with respect to whom the criminal investigation reveals any conviction for committing and/or attempting to commit any of the above enumerated offenses shall be employed thereby in any position that involves or may involve contact with the students of the school district.

This certification is executed on the date hereinafter indicated by the designated contractor by its duly authorized officer.

Firm: _____

By: _____
(Signature)

(Printed Name & Title)

Date: _____

Criminal Background Investigation

The undersigned hereby authorizes in Board of Education of Community High School District 99, Downers Grove, Illinois, to request a criminal background investigation from the Illinois State Police, pursuant to Section 5/10-21.9 of the School Code of Illinois, 105 ILCS 5/10-21.9 and to receive criminal history record information pursuant thereto.

By: _____
(Signature of Applicant of Employee)

(Printed or Typed Name of Applicant Employee)

Date: _____

BUSINESS CLASSIFICATION

a) Business Entity (check one)

Corporation (Publicly held)* Not-for-Profit* Government Agency/Public Institution*
 Corporation (Privately held) Partnership Sole Proprietor

* If checked, do not complete section III (b) and (c) below.

b) Business Ownership (check one) If minority or woman owned, attach copy of certification evidence.

Large Business: Male Owned Woman Owned
Small Business: Male Owned Woman Owned

BUSINESS DEFINITIONS

Small Business Concern - an independently owned and operated concern certified, or certifiable, as a small business by the Federal Small Business Administration (SBA). Standard Industrial Classification (SIC) codes may be found in the Federal Acquisition Regulations, Section 19.102 or in the Federal Procurement Regulations, Section 1-1.701.

Small Disadvantaged or Minority Business Concern - a small business concern which is at least fifty-one percent (51%) owned by one or more socially and economically disadvantaged individuals or in the case of any publicly owned business, at least fifty-one percent (51%) of the stock of which is owned by such individuals; and whose management and daily business operations are controlled by one or more of such individuals. Business owners who certify that they are members of named groups (Black Americans, Hispanic Americans, Native Americans, Asian-Pacific Americans) are considered socially and economically disadvantaged.

Woman-Owned Business - a business concern that is at least fifty-one percent (51%) owned by a woman or women who also control and operate it. "Control" in this context means exercising the power to make policy decisions. "Operate" in this context means being actively involved in the day-to-day management.

c) Race/Ethnicity of Ownership (check one) based on definitions below.

Black Asian/Pacific or Asian/Indian Caucasian
 Hispanic Native American (American Indians, Eskimos, Aleuts and native Hawaiians)

ETHNIC GROUP DEFINITIONS

Black Americans: United States citizens whose origins are in any of the Black racial groups of Africa.
Hispanic Americans: United States citizens whose origins are in Mexico, Puerto Rico, Cuba, Portugal, Central or Central America.
Native Americans: United States citizens whose origins are in any of the original peoples of North America, i.e., American Indians, Eskimos, Aleuts and native Hawaiians.
Asian Pacific/Asian Indian Americans: United States citizens whose origins are in Japan, China, Korea, Taiwan, Cambodia, Laos, Vietnam, the Philippines, Samoa, Guam, the U.S. Trust Territories of the Pacific Islands, the Northern Mariana Islands, India, Pakistan, or Bangladesh.

I certify that the business classification and ethnicity indicated above reflects the true and correct status of this business in accordance with current Federal Small Business Administration criteria. I agree to inform Community High School District 99 immediately in writing of any changes to the information contained herein, including changes in ownership, controlling interest or operations. I understand that falsely certifying this information may result in suspension from participation in Community High School District 99 – 2021 Capital Projects North & South

Name: _____ Title: _____
(Print or Type)

Signature: _____ Date: _____

END OF SECTION 004101

BID DATE: February 18th at 10:00 a.m. (CST)
(via Building Connected)

BID TO: Community High School District 99
Administrative Center
6301 Springside Avenue
Downers Grove, IL 60516

RECEIVED BY:

BID FROM: _____

BID FOR: Bid Group 1 - Bid Package #02 – General Trades
Transition Building
4232 Venard Road
Downers Grove, IL 60516

THE UNDERSIGNED:

Acknowledges receipt of:

Plans and specifications for the work indicated above.

Addenda: No. _____ dated _____
No. _____ dated _____
No. _____ dated _____
No. _____ dated _____

Having examined the site of the work, and having familiarized himself or herself with local conditions affecting the cost of the work and with all requirements of the bidding documents including Instructions to Bidders, drawings, specifications and duly issued addenda as prepared by the architect, Wight & Company, hereby agrees to perform all work and furnish all labor, material and equipment specifically required of him by the bidding documents and such additional work as may be included as related requirements in other divisions or sections of the specifications, exclusive of alternate bids.

Agrees:

To furnish and install the described material and/or services for stated lump sum price.

To hold this bid open until **90** calendar days after bid opening date.

To accept the provisions of the General Provisions (Project Manual Division 0 – Bidding & Contracting Requirements

Section 00201) and disposition of bid security.

To enter into and execute a contract with the Owner, if awarded on the basis of this bid, and in connection therewith to:

1. Furnish all bonds and insurance required by the bidding documents.
2. Accomplish the work in accordance with the contract.
3. Complete the work within the contract time herein specified.

Completion Time:

The undersigned agrees to begin construction immediately, or as directed by the Construction Manager, upon notice of contract award and to perform the following components of the work in accordance with the Construction Manager's Construction. This schedule is bound in the Project Manual. See attached scope of work in section 0300.

SCOPE OF WORK:

The work in this agreement (without additional compensation) shall include, but shall not necessarily be limited to, all skilled labor, supervision, premium time, materials, tools, equipment, plant, supplies, samples, shop drawings, design/engineering drawings, layout, transportation, supervision, contributions, insurance, taxes (if applicable), compliance with all agencies (City / Village, County, State, Federal and/or any other jurisdictional agency, as may be required) and/or all services and facilities necessary and/or required for the performance of all Work shown, detailed, and/or implied by the following documents and as defined herein.

It is understood that this Trade Contractor shall perform the Work for a complete and operational system as indicated or implied in all Contract Documents. It is recognized and understood that the documents upon which the bid is based are at a conceptual phase and this Contractor who has certain skills and judgments based upon his knowledge of techniques, procedures, systems, general state of the art of his specialty is expected to include in the scope of work, all items required in order to carry out a complete and functional system whether or not shown or described in the contract documents. This contract will be awarded on the basis of such documents with the understanding that this contractor is to furnish and install all items required for the proper completion of this work without adjustment to this contract price. No extra payments shall be made of claims entertained as a result of such items, unless it can be clearly demonstrated to be added scope to the contract and beyond the original intent of the documents.

Contractor to provide all Trade Contract work referenced in:

1. Any sheet of this bid group package including (reference Division 0 – Bidding and Contract Requirements, Section 00200 – Notice to Bidders).
2. Specification 00300 Bid Packages Scope Document.

WORK BASE BID: For providing all work including all allowances as required for the completion of the construction of the base bid project as shown on the drawings and specifications and NOT including alternate bids and/or contractor's proposed alternates and substitutes.

BASE BID

TOTAL BASE BID AMOUNT **TRANSITION BUILDING BUILD OUT:**

_____ Dollars (\$ _____)

1. This TRADE CONTRACTOR **shall include an allowance of \$15,000.00 in their base bid** to account for any Unforeseen Conditions, Additional Temporary / Safety Enclosures, and General Labor. Contract amounts will be adjusted by change order for amounts greater or less than the allowance. Allowance to be utilized only at the direction of Construction Manager.

- 2. This TRADE CONTRACTOR **shall include an allowance of \$5,000.00 to be included in the base bid for any misc. roof patching/ flashing.** Contract amounts will be adjusted by change order for amounts greater or less than the allowance. Allowance to be utilized only at the direction of Construction Manager.

BONDS:

This TRADE CONTRACTOR will be required to provide a Performance and Payment Bond for their work in accordance with 00201 of the General Conditions.

Award Basis:

The project will be awarded based upon the attached Evaluation Criteria, Section 301a. Owner and Construction Manager alternate's may be considered to find the most qualified bidder if the result of combining the base bid and the selected alternate(s) is the most qualified bid, and is to the benefit of the owner.

Each of the following amounts for alternate construction includes the entire cost of such construction, except as otherwise noted. Acceptance of any or all of the alternates for inclusion in the contract is the sole prerogative of the owner.

All additional costs due to the alternates are included in the amount to be added to the base bid, so that no additional costs will be borne by the owner due to acceptance of alternates. This alternate price is not to be included in the base bid price.

Owner Requested Alternates:

Each of the following amounts for alternate construction includes the entire cost of such construction, except as otherwise noted. Acceptance of any or all of the alternates for inclusion in the contract is the sole prerogative of the owner.

All additional costs due to the alternates are included in the amount to be added to the base bid, so that no additional costs will be borne by the owner due to acceptance of alternates.

Proposed Alternates: (Contractors Proposed Alternates)

Item Specified	Proposed Alternate	Change in Bid Price
1. _____	_____	_____
2. _____	_____	_____
3. _____	_____	_____

Owner Requested Unit Prices/Allowances (as applicable to this Trade Contractor's scope of work) (additive or deductive).

This trade contractor includes _____ dumpsters for all refuse caused by this trade contractor's work in the amount of _____ Dollars (\$_____) Note: trade contractors are to include in their bid form submittal the quantity of dumpsters required to complete their work and the cost associated with same. Dumpster costs will be subtracted by change order. Dumpsters will be procured and managed by Construction Manager. Note: Dumpster use in excess of that proposed by this Trade Contractor will be adjusted by back charge.

Owner Requested Scheduling Information:

Note: The work of this Trade Contractor is to be completed in accordance with the overall project schedule as identified elsewhere in this project manual and/or as subsequently directed by Construction Manager. This Trade Contractor shall submit a proposed submittals list/schedule/material log within five (5) calendar days of Notice To Proceed.

1. Shop drawings / Submittal for this trade contractor will be submitted within 10 calendar days of receipt of notice to proceed.

Bid Acceptance:

If written notice of the acceptance of this bid is mailed, telegraphed or delivered to the undersigned within the time noted herein, after the date of opening of bids or at any time thereafter before this bid is withdrawn, the undersigned agrees that he will execute a construction contract in accordance with the bids as accepted.

The Owner reserves the right to award the contract to its best interests, review and accept any and all value engineering alternatives, negotiate with the lowest responsible bidder, to reject any or all bids, to waive any informalities in bidding and to hold all bids for the bid guarantee period. The Owner reserves the right to award separate contracts for any of the items of work bid herein.

Bid Deposit:

The undersigned furnishes herewith, as required in the Instructions to Bidders, a bid deposit in the amount of ten percent (10%) of the amount bid in the form of Cashier's Check, or Certified Check, made payable to the Owner or Bid Bond, naming the Owner as obligee. (Bidder to check form of deposit furnished.)

It is understood and agreed that should the undersigned fail to enter into a contract with the Owner or furnish acceptable contract security within the time and in the manner herein provided, the bid deposit shall be retained by the Owner as liquidated damages and not as a forfeiture. As it is impossible to determine precisely an exact amount of damages the Owner will sustain, it is agreed that the bid deposit is a fair and equitable estimate of such damages.

REPRESENTATIONS AND CERTIFICATIONS:

The bidder makes the following representations and certifications as part of his bid on the project herein identified in the Bid Form. In the case of a joint venture bid, each party represents and certifies as to his own organization.

AVAILABILITY. The number and amount of contracts and awards pending which I am and/or will be obligated to perform, now and during the course of the project, will not interfere with or hinder the timely prosecution of my work.

SURETY. I have notified a Surety Company that I am submitting a bid for work to be performed on the project. The Surety Company has agreed to issue a performance and labor and material payment bond for my work, if my bid is accepted and the contract awarded to me.

INDEPENDENT PRICE DETERMINATION. The contract sum in this bid has been arrived at independently, without consultation, communication or agreement for the purpose of restricting competition.

PREVAILING WAGE. The contractor and each subcontractor shall pay not less than the general prevailing rate of hourly wages for work of a similar character in the locality in which the work is performed and not less than general prevailing rate of hourly wages for legal holidays and overtime work in the performance of work under this contract, as established by the Illinois Department of Labor, pursuant to an act of the General Assembly of the State of Illinois approved June 26, 1941 as amended according to Section 820 ILCS 130/1.

Pursuant to Section 820 ILCS 130/5, the contractor and each subcontractor shall keep an accurate record showing the names

and occupation of all laborers, workers and mechanics employed by them, and also showing the actual hourly wages paid to each such individual, which record shall be open at all reasonable hours to inspection by the Owner, its officers and agents, and to agents of the Illinois Department of Labor.

The contractor and each subcontractor hereby agree, jointly and severally, to defend, indemnify and hold harmless the Owner from any and all claims, demands, liens or suits of any kind or nature whatsoever (including suits for injunctive relief) by the Illinois Department of Labor under the Illinois Prevailing Wage Act, Section 820 ILCS 130/1., or by any laborer, worker or mechanic employed by the contractor or the subcontractor who alleges that he has been paid for his services in a sum less than prevailing wage rates required by Illinois law. The Owner agrees to notify the contractor or subcontractor of the pendency of any such claim, demand, lien or suit.

By submitting a bid, each bidder agrees to waive any claim it has or may have against the Owner, the Architect, Engineer, Construction Manager and their respective employees, arising out of or in connection with the administration, evaluation, or recommendation of any bid; waiver of any requirements under the Bid Documents; or the Contract Document; acceptance or rejection of any bids; and award of the Contract.

Signature:

Respectfully submitted this _____ day _____, 2021

Type of Firm (Bidder to indicate)

_____ Individual

_____ Partnership

_____ Corporation

_____ Joint Venture

_____ Other

(CORPORATE SEAL)

(Firm Name)

(Address)

(Telephone Number)

(FAX)

(E-mail Address)

(Bidder's Signature)

(Title)

Subscribed and sworn to me
this . day of __, 2020

NOTE: All pages of this bid form must be returned with your proposal. Failure to do so shall disqualify your bid.

CERTIFICATE OF BIDDER ELIGIBILITY

720 ILCS 5/33E-11 REQUIRES THAT ALL CONTRACTORS BIDDING FOR PUBLIC AGENCIES IN THE State of Illinois certify that they are not barred from bidding on public contracts for bid rigging or bid rotation.

The following certification must be signed and submitted with bidder's bid proposal. FAILURE TO DO SO MAY RESULT IN DISQUALIFICATION OF THE BIDDER.

_____, as part of its bid for the _____ work for Community High School District 99, Downers Grove, Illinois, DuPage County, Illinois certified that said contractor is not barred from bidding on the aforementioned contract as a result of violation of either 720 ILCS 5/33E-3 or 720 ILCS 5/33-E4.

Firm: _____

By: _____
(Signature)

(Printed Name & Title)

SUBSCRIBED AND SWORN TO before me

This _____ day of _____, 202

NOTARY PUBLIC

**CRIMINAL CODE CERTIFICATION
AS REQUIRED BY:
STATE OF ILLINOIS CRIMINAL CODE OF 2012, 720 ILCS 5/33E-11**

I, _____ the individual whose signature appears below on this bid/contract
for _____ hereby certify that the bidding party/contracting party
is not barred from bidding on the contract as a result of a violation of either Section 33E-3 or Section 33E-4 of 720 ILCS 5/33E-
3 or 5/33E-4 of the Illinois Compiled Statutes, as amended.

By: _____
Authorized Agent of Contractor (name and title)

SUBSCRIBED AND SWORN to before
me this ____ day _____, 20__.

Notary Public

EQUAL EMPLOYMENT OPPORTUNITY

Section I. This EQUAL EMPLOYMENT OPPORTUNITY CLAUSE is required by the Illinois Human Rights Act and the Rules and Regulations of the Illinois Department of Human Rights published at 44 Illinois Administrative Code Section 750, *et seq.*

Section II. In the event of the Contractor's noncompliance with any provision of this Equal Employment Opportunity Clause, the Illinois Human Rights Act, or the Rules and Regulations of the Department of Human Rights (hereinafter referred to as the Department) the Contractor may be declared ineligible for future contracts or subcontracts with the State of Illinois or any of its political subdivisions or municipal corporations, and this Contract may be canceled or voided in whole or in part, and other sanctions or penalties may be imposed or remedies involved as provided by statute or regulation.

During the performance of this Agreement, the Contractor agrees:

A. That it will not discriminate against any employee or applicant for employment because of race, color, religion, sex, sexual orientation, national origin or ancestry, citizenship status, age, physical or mental disability unrelated to ability, military status or an unfavorable discharge from military service; and further that it will examine all job classifications to determine if minority persons or women are underutilized and will take appropriate affirmative action to rectify any such underutilization.

B. That, if it hires additional employees in order to perform this Contract, or any portion hereof, it will determine the availability (in accordance with the Department's Rules and Regulations) of minorities and women in the area(s) from which it may reasonably recruit and it will hire for each job classification for which employees are hired in such a way that minorities and women are not underutilized.

C. That, in all solicitations or advertisements for employees placed by it or on its behalf, it will state that all applicants will be afforded equal opportunity without discrimination because of race, color, religion, sex, sexual orientation, marital status, national origin or ancestry, citizenship status, age, or physical or mental handicap unrelated to ability, military status or an unfavorable discharge from military service.

D. That it will send to each labor organization or representative of workers with which it has or is bound by a collective bargaining or other agreement or understanding, a notice advising such labor organization or representative of the Vendor's obligations under the Illinois Human Rights Act and Department's Rules and Regulations. If any labor organization or representative fails or refuses to cooperate with the Contractor in its efforts to comply with the Act and Rules and Regulations, the Contractor will promptly notify the Department and the contracting agency and will recruit employees from other sources when necessary to fulfill its obligations under the Contract.

E. That it will submit reports as required by the Department's Rules and Regulations, furnish all relevant information as may from time to time be requested by the Department or the contracting agency, and in all respects comply with the Illinois Human Rights Act and Department's Rules and Regulations.

F. That it will permit access to all relevant books, records, accounts and work sites by personnel of the contracting agency and Department for purposes of investigation to ascertain compliance with the Illinois Human Rights Act and Department's Rules and Regulations.

G. That it will include verbatim or by reference the provisions of this Equal Employment Opportunity Clause in every subcontract it awards under which any portion of this Contract obligations are undertaken or assumed, so that such provisions will be binding upon such subcontractor. In the same manner as the other provisions of this Agreement, the Contractor will be liable for compliance with applicable provisions of this clause by such subcontractors; and further it will promptly notify the contracting agency and the Department in the event any subcontractor fails or refuses to comply therewith. In addition, the Contractor will not utilize any subcontractor declared by the Illinois Human Rights Department to be ineligible for contracts or subcontracts with the State of Illinois or any of its political subdivisions or municipal corporations.

ACKNOWLEDGED AND AGREED TO:

By: _____
Authorized Agent of Contractor (name and title)

DATE: _____

SEXUAL HARASSMENT POLICY

_____, having submitted a bid for _____ (Name of Contractor)
_____ to Community High School District No. 00, hereby certifies that
said contractor has a written sexual harassment policy in place in full compliance with 775 ILCS 5/2-105 (A) (4).

By: _____
Authorized Agent of Contractor (name and title)

SUBSCRIBED AND SWORN to before
me this ____ day _____, 20__.

Notary Public

TAX CERTIFICATION

I, _____, having been first duly sworn depose and state as follows:

I, _____, am the duly authorized agent for
High School District No. 99 for

_____ and I hereby certify that _____ is not delinquent in the payment of any tax administered by the Illinois Department of Revenue, or if it is:

a. it is contesting its liability for the tax or the amount of tax in accordance with procedures established by the appropriate Revenue Act; or

b. it has entered into an agreement with the Department of Revenue for payment of all taxes due and is currently in compliance with that agreement.

By: _____
Authorized Agent of Contractor (name and title)

SUBSCRIBED AND SWORN to before
me this ____ day _____, 20__.

Notary Public

SUBSTANCE ABUSE PREVENTION ON PUBLIC WORKS PROJECTS

The Contractor certifies that it has in place a written program that meets or exceeds the program requirements of the Substance Abuse Prevention on Public Works Projects Act (Public Act 95-0635), and will provide a copy thereof to Community High School District No. 99 prior to commencement of work on the Project.

By: _____
Authorized Agent of Contractor (name and title)

SUBSCRIBED AND SWORN to before
me this ____ day _____, 20__.

Notary Public

**CERTIFICATE REGARDING
EMPLOYMENT OF ILLINOIS WORKERS ON PUBLIC WORKS**

_____ agrees if at the time the Agreement is executed, or if during the term of the Agreement, there is excessive unemployment in Illinois as defined in the Employment of Illinois Workers on Public Works Act, 30- ILCS 570/0/01 et seq., as two consecutive months of unemployment exceeding 5%, then _____ agrees to employ Illinois laborers in accordance with the Employment of Illinois Workers on Public Works Act. An "Illinois laborer" is defined as any person who has resided in Illinois for at least thirty (30) days and intends to become or remain an Illinois resident.

Firm: _____

By: _____
(Signature)

(Printed Name & Title)

SUBSCRIBED AND SWORN TO before me

This _____ day of _____, 2021

NOTARY PUBLIC

PREVAILING WAGE AFFIDAVIT

AFFIDAVIT: "I (we) hereby certify and affirm that if awarded a contract with Community High School District 99, we will comply fully with the "Illinois Prevailing Wage Act (Ill. Rev. Stat., 1987 Ch. 48, Sections 398 s-1-12 as amended by Public Act 86-693 and 86-799 effected January 1, 1990, and any other amendments effective thereafter)". We further understand that current prevailing wage standards are included in the Supplementary General Conditions.

The following affidavit must be signed and submitted with bidder's bid proposal. FAILURE TO DO SO MAY RESULT IN DISQUALIFICATION OF THE BIDDER.

_____, as part of its bid for the _____ work for Community High School District 99, Downers Grove, Illinois, certifies that said contractor is not barred from bidding on the aforementioned contract as a result of a violation of the Illinois Prevailing Wage Act (Ill. Rev. Stat., 1987 Ch. 48, Sections 398 s-1-12 as amended by Public Act 86-693 and 86-799 effected January 1, 1990).

Firm: _____

By: _____
(Signature)

(Printed Name & Title)

SUBSCRIBED AND SWORN TO before me

This _____ day of _____, 2021

NOTARY PUBLIC

NON-COLLUSION AFFIDAVIT

AFFIDAVIT: "I (we) hereby certify and affirm that my (our) proposal was prepared independently for this project and that it contains no fees or amounts other than that for the legitimate execution of this work as specified and that it includes no understanding or agreements in restraint of trade."

The following affidavit must be signed and submitted with bidder's bid proposal.
FAILURE TO DO SO MAY RESULT IN DISQUALIFICATION OF THE BIDDER.

_____, as a part of its bid for the _____ work for Community High School District 99, Downers Grove, Illinois, certifies that said Contractor is not barred from bidding on the aforementioned contract as a result of a violation of the above Non-Collusion Affidavit.

Firm: _____

By: _____
(Signature)

(Printed Name & Title)

SUBSCRIBED AND SWORN TO before me

This _____ day of _____, 2021

NOTARY PUBLIC

Criminal Background Investigations

Contractor hereby represents, warrants and certified that no officer or director thereof has any knowledge that any employee thereof has been convicted of committing or attempting to commit "Criminal Code of 1961," 720 ILCS, Sections 5/11-6 (Indecent solicitation of a child), 5/11-9 (Public indecency), 5/11-14 (Prostitution), 5/11-15 (Soliciting for a prostitute), 5/11-15.1 (Soliciting for a juvenile prostitute), 5/11-19 (Pimping), 5/11-19.1 (Juvenile pimping), 5/11-19.2 (Exploitation of a child), 5/11-20 (Obscenity), 5/11-20.1 (Sexual assault), 5/12-14 (Aggravated criminal sexual assault), 5/12-15 (Criminal sexual abuse), and 5/120-16 (Aggravated criminal sexual abuse), and/or those offenses defined in the "Cannabis Control Act," 720 ILCS, 550/1 et seq. (except the "Illinois Controlled Substances Act," 720 ILCS 570/100 et seq. and/or any offense committed or attempted in any other state or against the laws of the United States, which if committed or attempted in this State, would have been punishable as one or more of the foregoing offenses.

Contractor further agrees that it shall not employ any person who have or may have direct, daily contact with the pupils of any school in the district, and for whom a criminal background investigation has not been conducted pursuant hereto, and further represents and agrees that all applicants for any such employment shall furnish with their applications the attached written "Authorization for Criminal Background Information" form authorizing the Board of Education to request a criminal background investigation of said applicant pursuant to Section 5/10-21.9 of the School Code of Illinois and to receive criminal history record information pursuant thereto to determine if the applicant has been convicted of committing or attempting to commit any of the criminal or drug offenses enumerated above. Contractor further agrees to submit with said authorization payment for any costs and expenses associated with the criminal background investigation.

Contractor further represents, warrants, and certifies that no applicant for employment with respect to whom the criminal investigation reveals any conviction for committing and/or attempting to commit any of the above enumerated offenses shall be employed thereby in any position that involves or may involve contact with the students of the school district.

This certification is executed on the date hereinafter indicated by the designated contractor by its duly authorized officer.

Firm: _____

By: _____
(Signature)

(Printed Name & Title)

Date: _____

Criminal Background Investigation

The undersigned hereby authorizes in Board of Education of Community High School District 99, Downers Grove, Illinois, to request a criminal background investigation from the Illinois State Police, pursuant to Section 5/10-21.9 of the School Code of Illinois, 105 ILCS 5/10-21.9 and to receive criminal history record information pursuant thereto.

By: _____
(Signature of Applicant of Employee)

(Printed or Typed Name of Applicant Employee)

Date: _____

BUSINESS CLASSIFICATION

a) Business Entity (check one)

Corporation (Publicly held)* Not-for-Profit* Government Agency/Public Institution*
 Corporation (Privately held) Partnership Sole Proprietor

* If checked, do not complete section III (b) and (c) below.

b) Business Ownership (check one) If minority or woman owned, attach copy of certification evidence.

Large Business: Male Owned Woman Owned
Small Business: Male Owned Woman Owned

BUSINESS DEFINITIONS

Small Business Concern - an independently owned and operated concern certified, or certifiable, as a small business by the Federal Small Business Administration (SBA). Standard Industrial Classification (SIC) codes may be found in the Federal Acquisition Regulations, Section 19.102 or in the Federal Procurement Regulations, Section 1-1.701.

Small Disadvantaged or Minority Business Concern - a small business concern which is at least fifty-one percent (51%) owned by one or more socially and economically disadvantaged individuals or in the case of any publicly owned business, at least fifty-one percent (51%) of the stock of which is owned by such individuals; and whose management and daily business operations are controlled by one or more of such individuals. Business owners who certify that they are members of named groups (Black Americans, Hispanic Americans, Native Americans, Asian-Pacific Americans) are considered socially and economically disadvantaged.

Woman-Owned Business - a business concern that is at least fifty-one percent (51%) owned by a woman or women who also control and operate it. "Control" in this context means exercising the power to make policy decisions. "Operate" in this context means being actively involved in the day-to-day management.

c) Race/Ethnicity of Ownership (check one) based on definitions below.

Black Asian/Pacific or Asian/Indian Caucasian
 Hispanic Native American (American Indians, Eskimos, Aleuts and native Hawaiians)

ETHNIC GROUP DEFINITIONS

Black Americans: United States citizens whose origins are in any of the Black racial groups of Africa.
Hispanic Americans: United States citizens whose origins are in Mexico, Puerto Rico, Cuba, Portugal, Central or Central America.
Native Americans: United States citizens whose origins are in any of the original peoples of North America, i.e., American Indians, Eskimos, Aleuts and native Hawaiians.
Asian Pacific/Asian Indian Americans: United States citizens whose origins are in Japan, China, Korea, Taiwan, Cambodia, Laos, Vietnam, the Philippines, Samoa, Guam, the U.S. Trust Territories of the Pacific Islands, the Northern Mariana Islands, India, Pakistan, or Bangladesh.

I certify that the business classification and ethnicity indicated above reflects the true and correct status of this business in accordance with current Federal Small Business Administration criteria. I agree to inform Community High School District 99 immediately in writing of any changes to the information contained herein, including changes in ownership, controlling interest or operations. I understand that falsely certifying this information may result in suspension from participation in Community High School District 99 – 2021 Capital Projects North & South

Name: _____ Title: _____
(Print or Type)

Signature: _____ Date: _____

END OF SECTION 004101

BID DATE: February 18th at 10:00 a.m. (CST)
(via Building Connected)

BID TO: Community High School District 99
Administrative Center
6301 Springside Avenue
Downers Grove, IL 60516

RECEIVED BY:

BID FROM: _____

BID FOR: Bid Group 1 - Bid Package #03 – Drywall and Framing
Transition Building
4232 Venard Road
Downers Grove, IL 60516

THE UNDERSIGNED:

Acknowledges receipt of:

Plans and specifications for the work indicated above.

Addenda: No. _____ dated _____
No. _____ dated _____
No. _____ dated _____
No. _____ dated _____

Having examined the site of the work, and having familiarized himself or herself with local conditions affecting the cost of the work and with all requirements of the bidding documents including Instructions to Bidders, drawings, specifications and duly issued addenda as prepared by the architect, Wight & Company, hereby agrees to perform all work and furnish all labor, material and equipment specifically required of him by the bidding documents and such additional work as may be included as related requirements in other divisions or sections of the specifications, exclusive of alternate bids.

Agrees:

To furnish and install the described material and/or services for stated lump sum price.

To hold this bid open until **90** calendar days after bid opening date.

To accept the provisions of the General Provisions (Project Manual Division 0 – Bidding & Contracting Requirements

Section 00201) and disposition of bid security.

To enter into and execute a contract with the Owner, if awarded on the basis of this bid, and in connection therewith to:

1. Furnish all bonds and insurance required by the bidding documents.
2. Accomplish the work in accordance with the contract.
3. Complete the work within the contract time herein specified.

Completion Time:

The undersigned agrees to begin construction immediately, or as directed by the Construction Manager, upon notice of contract award and to perform the following components of the work in accordance with the Construction Manager's Construction. This schedule is bound in the Project Manual. See attached scope of work in section 0300.

SCOPE OF WORK:

The work in this agreement (without additional compensation) shall include, but shall not necessarily be limited to, all skilled labor, supervision, premium time, materials, tools, equipment, plant, supplies, samples, shop drawings, design/engineering drawings, layout, transportation, supervision, contributions, insurance, taxes (if applicable), compliance with all agencies (City / Village, County, State, Federal and/or any other jurisdictional agency, as may be required) and/or all services and facilities necessary and/or required for the performance of all Work shown, detailed, and/or implied by the following documents and as defined herein.

It is understood that this Trade Contractor shall perform the Work for a complete and operational system as indicated or implied in all Contract Documents. It is recognized and understood that the documents upon which the bid is based are at a conceptual phase and this Contractor who has certain skills and judgments based upon his knowledge of techniques, procedures, systems, general state of the art of his specialty is expected to include in the scope of work, all items required in order to carry out a complete and functional system whether or not shown or described in the contract documents. This contract will be awarded on the basis of such documents with the understanding that this contractor is to furnish and install all items required for the proper completion of this work without adjustment to this contract price. No extra payments shall be made of claims entertained as a result of such items, unless it can be clearly demonstrated to be added scope to the contract and beyond the original intent of the documents.

Contractor to provide all Trade Contract work referenced in:

1. Any sheet of this bid group package including (reference Division 0 – Bidding and Contract Requirements, Section 00200 – Notice to Bidders).
2. Specification 00300 Bid Packages Scope Document.

WORK BASE BID: For providing all work including all allowances as required for the completion of the construction of the base bid project as shown on the drawings and specifications and NOT including alternate bids and/or contractor's proposed alternates and substitutes.

BASE BID

TOTAL BASE BID AMOUNT **TRANSITION BUILDING BUILD OUT:**

_____ Dollars (\$ _____)

1. This TRADE CONTRACTOR **shall include an allowance of \$10,000.00 in their base bid** to account for any unforeseen conditions. Contract amounts will be adjusted by change order for amounts greater or less than the allowance. Allowance to be utilized only at the direction of Construction Manager.

BONDS:

This TRADE CONTRACTOR will be required to provide a Performance and Payment Bond for their work in accordance with 00201 of the General Conditions.

Award Basis:

The project will be awarded based upon the attached Evaluation Criteria, Section 301a. Owner and Construction Manager alternate's may be considered to find the most qualified bidder if the result of combining the base bid and the selected alternate(s) is the most qualified bid, and is to the benefit of the owner.

Each of the following amounts for alternate construction includes the entire cost of such construction, except as otherwise noted. Acceptance of any or all of the alternates for inclusion in the contract is the sole prerogative of the owner.

All additional costs due to the alternates are included in the amount to be added to the base bid, so that no additional costs will be borne by the owner due to acceptance of alternates. This alternate price is not to be included in the base bid price.

Owner Requested Alternates:

Each of the following amounts for alternate construction includes the entire cost of such construction, except as otherwise noted. Acceptance of any or all of the alternates for inclusion in the contract is the sole prerogative of the owner.

All additional costs due to the alternates are included in the amount to be added to the base bid, so that no additional costs will be borne by the owner due to acceptance of alternates.

Proposed Alternates: (Contractors Proposed Alternates)

Item Specified	Proposed Alternate	Change in Bid Price
1. _____	_____	_____
2. _____	_____	_____
3. _____	_____	_____

Owner Requested Unit Prices/Allowances (as applicable to this Trade Contractor's scope of work) (additive or deductive).

This trade contractor includes _____ dumpsters for all refuse caused by this trade contractor's work in the amount of _____ Dollars (\$_____) Note: trade contractors are to include in their bid form submittal the quantity of dumpsters required to complete their work and the cost associated with same. Dumpster costs will be subtracted by change order. Dumpsters will be procured and managed by Construction Manager. Note: Dumpster use in excess of that proposed by this Trade Contractor will be adjusted by back charge.

Owner Requested Scheduling Information:

Note: The work of this Trade Contractor is to be completed in accordance with the overall project schedule as identified elsewhere in this project manual and/or as subsequently directed by Construction Manager. This Trade Contractor shall submit a proposed submittals list/schedule/material log within five (5) calendar days of Notice To Proceed.

1. Shop drawings / Submittal for this trade contractor will be submitted within 10 calendar days of receipt of notice to proceed.

Bid Acceptance:

If written notice of the acceptance of this bid is mailed, telegraphed or delivered to the undersigned within the time noted herein, after the date of opening of bids or at any time thereafter before this bid is withdrawn, the undersigned agrees that he will execute a construction contract in accordance with the bids as accepted.

The Owner reserves the right to award the contract to its best interests, review and accept any and all value engineering alternatives, negotiate with the lowest responsible bidder, to reject any or all bids, to waive any informalities in bidding and to hold all bids for the bid guarantee period. The Owner reserves the right to award separate contracts for any of the items of work bid herein.

Bid Deposit:

The undersigned furnishes herewith, as required in the Instructions to Bidders, a bid deposit in the amount of ten percent (10%) of the amount bid in the form of Cashier's Check, or Certified Check, made payable to the Owner or Bid Bond, naming the Owner as obligee. (Bidder to check form of deposit furnished.)

It is understood and agreed that should the undersigned fail to enter into a contract with the Owner or furnish acceptable contract security within the time and in the manner herein provided, the bid deposit shall be retained by the Owner as liquidated damages and not as a forfeiture. As it is impossible to determine precisely an exact amount of damages the Owner will sustain, it is agreed that the bid deposit is a fair and equitable estimate of such damages.

REPRESENTATIONS AND CERTIFICATIONS:

The bidder makes the following representations and certifications as part of his bid on the project herein identified in the Bid Form. In the case of a joint venture bid, each party represents and certifies as to his own organization.

AVAILABILITY. The number and amount of contracts and awards pending which I am and/or will be obligated to perform, now and during the course of the project, will not interfere with or hinder the timely prosecution of my work.

SURETY. I have notified a Surety Company that I am submitting a bid for work to be performed on the project. The Surety Company has agreed to issue a performance and labor and material payment bond for my work, if my bid is accepted and the contract awarded to me.

INDEPENDENT PRICE DETERMINATION. The contract sum in this bid has been arrived at independently, without consultation, communication or agreement for the purpose of restricting competition.

PREVAILING WAGE. The contractor and each subcontractor shall pay not less than the general prevailing rate of hourly wages for work of a similar character in the locality in which the work is performed and not less than general prevailing rate of hourly wages for legal holidays and overtime work in the performance of work under this contract, as established by the Illinois Department of Labor, pursuant to an act of the General Assembly of the State of Illinois approved June 26, 1941 as amended according to Section 820 ILCS 130/1.

Pursuant to Section 820 ILCS 130/5, the contractor and each subcontractor shall keep an accurate record showing the names and occupation of all laborers, workers and mechanics employed by them, and also showing the actual hourly wages paid to each such individual, which record shall be open at all reasonable hours to inspection by the Owner, its officers and agents, and to agents of the Illinois Department of Labor.

The contractor and each subcontractor hereby agree, jointly and severally, to defend, indemnify and hold harmless the Owner from any and all claims, demands, liens or suits of any kind or nature whatsoever (including suits for injunctive relief) by the Illinois Department of Labor under the Illinois Prevailing Wage Act, Section 820 ILCS 130/1., or by any laborer, worker or mechanic employed by the contractor or the subcontractor who alleges that he has been paid for his services in a sum less than prevailing wage rates required by Illinois law. The Owner agrees to notify the contractor or subcontractor of the pendency of any such claim, demand, lien or suit.

By submitting a bid, each bidder agrees to waive any claim it has or may have against the Owner, the Architect, Engineer, Construction Manager and their respective employees, arising out of or in connection with the administration, evaluation, or recommendation of any bid; waiver of any requirements under the Bid Documents; or the Contract Document; acceptance or rejection of any bids; and award of the Contract.

Signature:

Respectfully submitted this _____ day _____, 2021

Type of Firm (Bidder to indicate)

_____ Individual

_____ Partnership

_____ Corporation

_____ Joint Venture

_____ Other

(CORPORATE SEAL)

(Firm Name)

(Address)

(Telephone Number)

(FAX)

(E-mail Address)

(Bidder's Signature)

(Title)

Subscribed and sworn to me
this . day of __, 2020

NOTE: All pages of this bid form must be returned with your proposal. Failure to do so shall disqualify your bid.

CERTIFICATE OF BIDDER ELIGIBILITY

720 ILCS 5/33E-11 REQUIRES THAT ALL CONTRACTORS BIDDING FOR PUBLIC AGENCIES IN THE State of Illinois certify that they are not barred from bidding on public contracts for bid rigging or bid rotation.

The following certification must be signed and submitted with bidder's bid proposal. FAILURE TO DO SO MAY RESULT IN DISQUALIFICATION OF THE BIDDER.

_____, as part of its bid for the _____ work for Community High School District 99, Downers Grove, Illinois, DuPage County, Illinois certified that said contractor is not barred from bidding on the aforementioned contract as a result of violation of either 720 ILCS 5/33E-3 or 720 ILCS 5/33-E4.

Firm: _____

By: _____
(Signature)

(Printed Name & Title)

SUBSCRIBED AND SWORN TO before me

This _____ day of _____, 202

NOTARY PUBLIC

**CRIMINAL CODE CERTIFICATION
AS REQUIRED BY:
STATE OF ILLINOIS CRIMINAL CODE OF 2012, 720 ILCS 5/33E-11**

I, _____ the individual whose signature appears below on this bid/contract
for _____ hereby certify that the bidding party/contracting party
is not barred from bidding on the contract as a result of a violation of either Section 33E-3 or Section 33E-4 of 720 ILCS 5/33E-
3 or 5/33E-4 of the Illinois Compiled Statutes, as amended.

By: _____
Authorized Agent of Contractor (name and title)

SUBSCRIBED AND SWORN to before
me this ____ day _____, 20__.

Notary Public

EQUAL EMPLOYMENT OPPORTUNITY

Section I. This EQUAL EMPLOYMENT OPPORTUNITY CLAUSE is required by the Illinois Human Rights Act and the Rules and Regulations of the Illinois Department of Human Rights published at 44 Illinois Administrative Code Section 750, *et seq.*

Section II. In the event of the Contractor's noncompliance with any provision of this Equal Employment Opportunity Clause, the Illinois Human Rights Act, or the Rules and Regulations of the Department of Human Rights (hereinafter referred to as the Department) the Contractor may be declared ineligible for future contracts or subcontracts with the State of Illinois or any of its political subdivisions or municipal corporations, and this Contract may be canceled or voided in whole or in part, and other sanctions or penalties may be imposed or remedies involved as provided by statute or regulation.

During the performance of this Agreement, the Contractor agrees:

A. That it will not discriminate against any employee or applicant for employment because of race, color, religion, sex, sexual orientation, national origin or ancestry, citizenship status, age, physical or mental disability unrelated to ability, military status or an unfavorable discharge from military service; and further that it will examine all job classifications to determine if minority persons or women are underutilized and will take appropriate affirmative action to rectify any such underutilization.

B. That, if it hires additional employees in order to perform this Contract, or any portion hereof, it will determine the availability (in accordance with the Department's Rules and Regulations) of minorities and women in the area(s) from which it may reasonably recruit and it will hire for each job classification for which employees are hired in such a way that minorities and women are not underutilized.

C. That, in all solicitations or advertisements for employees placed by it or on its behalf, it will state that all applicants will be afforded equal opportunity without discrimination because of race, color, religion, sex, sexual orientation, marital status, national origin or ancestry, citizenship status, age, or physical or mental handicap unrelated to ability, military status or an unfavorable discharge from military service.

D. That it will send to each labor organization or representative of workers with which it has or is bound by a collective bargaining or other agreement or understanding, a notice advising such labor organization or representative of the Vendor's obligations under the Illinois Human Rights Act and Department's Rules and Regulations. If any labor organization or representative fails or refuses to cooperate with the Contractor in its efforts to comply with the Act and Rules and Regulations, the Contractor will promptly notify the Department and the contracting agency and will recruit employees from other sources when necessary to fulfill its obligations under the Contract.

E. That it will submit reports as required by the Department's Rules and Regulations, furnish all relevant information as may from time to time be requested by the Department or the contracting agency, and in all respects comply with the Illinois Human Rights Act and Department's Rules and Regulations.

F. That it will permit access to all relevant books, records, accounts and work sites by personnel of the contracting agency and Department for purposes of investigation to ascertain compliance with the Illinois Human Rights Act and Department's Rules and Regulations.

G. That it will include verbatim or by reference the provisions of this Equal Employment Opportunity Clause in every subcontract it awards under which any portion of this Contract obligations are undertaken or assumed, so that such provisions will be binding upon such subcontractor. In the same manner as the other provisions of this Agreement, the Contractor will be liable for compliance with applicable provisions of this clause by such subcontractors; and further it will promptly notify the contracting agency and the Department in the event any subcontractor fails or refuses to comply therewith. In addition, the Contractor will not utilize any subcontractor declared by the Illinois Human Rights Department to be ineligible for contracts or subcontracts with the State of Illinois or any of its political subdivisions or municipal corporations.

ACKNOWLEDGED AND AGREED TO:

By: _____
Authorized Agent of Contractor (name and title)

DATE: _____

SEXUAL HARASSMENT POLICY

_____, having submitted a bid for _____ (Name of Contractor)
_____ to Community High School District No. 00, hereby certifies that
said contractor has a written sexual harassment policy in place in full compliance with 775 ILCS 5/2-105 (A) (4).

By: _____
Authorized Agent of Contractor (name and title)

SUBSCRIBED AND SWORN to before
me this ____ day _____, 20__.

Notary Public

TAX CERTIFICATION

I, _____, having been first duly sworn depose and state as follows:

I, _____, am the duly authorized agent for
High School District No. 99 for

_____ and I hereby certify that _____ is not delinquent in the payment of any tax administered by the Illinois Department of Revenue, or if it is:

a. it is contesting its liability for the tax or the amount of tax in accordance with procedures established by the appropriate Revenue Act; or

b. it has entered into an agreement with the Department of Revenue for payment of all taxes due and is currently in compliance with that agreement.

By: _____
Authorized Agent of Contractor (name and title)

SUBSCRIBED AND SWORN to before
me this ____ day _____, 20__.

Notary Public

SUBSTANCE ABUSE PREVENTION ON PUBLIC WORKS PROJECTS

The Contractor certifies that it has in place a written program that meets or exceeds the program requirements of the Substance Abuse Prevention on Public Works Projects Act (Public Act 95-0635), and will provide a copy thereof to Community High School District No. 99 prior to commencement of work on the Project.

By: _____
Authorized Agent of Contractor (name and title)

SUBSCRIBED AND SWORN to before
me this ____ day _____, 20__.

Notary Public

**CERTIFICATE REGARDING
EMPLOYMENT OF ILLINOIS WORKERS ON PUBLIC WORKS**

_____ agrees if at the time the Agreement is executed, or if during the term of the Agreement, there is excessive unemployment in Illinois as defined in the Employment of Illinois Workers on Public Works Act, 30- ILCS 570/0/01 et seq., as two consecutive months of unemployment exceeding 5%, then _____ agrees to employ Illinois laborers in accordance with the Employment of Illinois Workers on Public Works Act. An "Illinois laborer" is defined as any person who has resided in Illinois for at least thirty (30) days and intends to become or remain an Illinois resident.

Firm: _____

By: _____
(Signature)

(Printed Name & Title)

SUBSCRIBED AND SWORN TO before me

This _____ day of _____, 2021

NOTARY PUBLIC

PREVAILING WAGE AFFIDAVIT

AFFIDAVIT: "I (we) hereby certify and affirm that if awarded a contract with Community High School District 99, we will comply fully with the "Illinois Prevailing Wage Act (Ill. Rev. Stat., 1987 Ch. 48, Sections 398 s-1-12 as amended by Public Act 86-693 and 86-799 effected January 1, 1990, and any other amendments effective thereafter)". We further understand that current prevailing wage standards are included in the Supplementary General Conditions.

The following affidavit must be signed and submitted with bidder's bid proposal. FAILURE TO DO SO MAY RESULT IN DISQUALIFICATION OF THE BIDDER.

_____, as part of its bid for the _____ work for Community High School District 99, Downers Grove, Illinois, certifies that said contractor is not barred from bidding on the aforementioned contract as a result of a violation of the Illinois Prevailing Wage Act (Ill. Rev. Stat., 1987 Ch. 48, Sections 398 s-1-12 as amended by Public Act 86-693 and 86-799 effected January 1, 1990).

Firm: _____

By: _____
(Signature)

(Printed Name & Title)

SUBSCRIBED AND SWORN TO before me

This _____ day of _____, 2021

NOTARY PUBLIC

NON-COLLUSION AFFIDAVIT

AFFIDAVIT: "I (we) hereby certify and affirm that my (our) proposal was prepared independently for this project and that it contains no fees or amounts other than that for the legitimate execution of this work as specified and that it includes no understanding or agreements in restraint of trade."

The following affidavit must be signed and submitted with bidder's bid proposal.
FAILURE TO DO SO MAY RESULT IN DISQUALIFICATION OF THE BIDDER.

_____, as a part of its bid for the _____ work for Community High School District 99, Downers Grove, Illinois, certifies that said Contractor is not barred from bidding on the aforementioned contract as a result of a violation of the above Non-Collusion Affidavit.

Firm: _____

By: _____
(Signature)

(Printed Name & Title)

SUBSCRIBED AND SWORN TO before me

This _____ day of _____, 2021

NOTARY PUBLIC

Criminal Background Investigations

Contractor hereby represents, warrants and certified that no officer or director thereof has any knowledge that any employee thereof has been convicted of committing or attempting to commit "Criminal Code of 1961," 720 ILCS, Sections 5/11-6 (Indecent solicitation of a child), 5/11-9 (Public indecency), 5/11-14 (Prostitution), 5/11-15 (Soliciting for a prostitute), 5/11-15.1 (Soliciting for a juvenile prostitute), 5/11-19 (Pimping), 5/11-19.1 (Juvenile pimping), 5/11-19.2 (Exploitation of a child), 5/11-20 (Obscenity), 5/11-20.1 (Sexual assault), 5/12-14 (Aggravated criminal sexual assault), 5/12-15 (Criminal sexual abuse), and 5/120-16 (Aggravated criminal sexual abuse), and/or those offenses defined in the "Cannabis Control Act," 720 ILCS, 550/1 et seq. (except the "Illinois Controlled Substances Act," 720 ILCS 570/100 et seq. and/or any offense committed or attempted in any other state or against the laws of the United States, which if committed or attempted in this State, would have been punishable as one or more of the foregoing offenses.

Contractor further agrees that it shall not employ any person who have or may have direct, daily contact with the pupils of any school in the district, and for whom a criminal background investigation has not been conducted pursuant hereto, and further represents and agrees that all applicants for any such employment shall furnish with their applications the attached written "Authorization for Criminal Background Information" form authorizing the Board of Education to request a criminal background investigation of said applicant pursuant to Section 5/10-21.9 of the School Code of Illinois and to receive criminal history record information pursuant thereto to determine if the applicant has been convicted of committing or attempting to commit any of the criminal or drug offenses enumerated above. Contractor further agrees to submit with said authorization payment for any costs and expenses associated with the criminal background investigation.

Contractor further represents, warrants, and certifies that no applicant for employment with respect to whom the criminal investigation reveals any conviction for committing and/or attempting to commit any of the above enumerated offenses shall be employed thereby in any position that involves or may involve contact with the students of the school district.

This certification is executed on the date hereinafter indicated by the designated contractor by its duly authorized officer.

Firm: _____

By: _____
(Signature)

(Printed Name & Title)

Date: _____

Criminal Background Investigation

The undersigned hereby authorizes in Board of Education of Community High School District 99, Downers Grove, Illinois, to request a criminal background investigation from the Illinois State Police, pursuant to Section 5/10-21.9 of the School Code of Illinois, 105 ILCS 5/10-21.9 and to receive criminal history record information pursuant thereto.

By: _____
(Signature of Applicant of Employee)

(Printed or Typed Name of Applicant Employee)

Date: _____

BUSINESS CLASSIFICATION

a) Business Entity (check one)

Corporation (Publicly held)* Not-for-Profit* Government Agency/Public Institution*
 Corporation (Privately held) Partnership Sole Proprietor

* If checked, do not complete section III (b) and (c) below.

b) Business Ownership (check one) If minority or woman owned, attach copy of certification evidence.

Large Business: Male Owned Woman Owned
Small Business: Male Owned Woman Owned

BUSINESS DEFINITIONS

Small Business Concern - an independently owned and operated concern certified, or certifiable, as a small business by the Federal Small Business Administration (SBA). Standard Industrial Classification (SIC) codes may be found in the Federal Acquisition Regulations, Section 19.102 or in the Federal Procurement Regulations, Section 1-1.701.

Small Disadvantaged or Minority Business Concern - a small business concern which is at least fifty-one percent (51%) owned by one or more socially and economically disadvantaged individuals or in the case of any publicly owned business, at least fifty-one percent (51%) of the stock of which is owned by such individuals; and whose management and daily business operations are controlled by one or more of such individuals. Business owners who certify that they are members of named groups (Black Americans, Hispanic Americans, Native Americans, Asian-Pacific Americans) are considered socially and economically disadvantaged.

Woman-Owned Business - a business concern that is at least fifty-one percent (51%) owned by a woman or women who also control and operate it. "Control" in this context means exercising the power to make policy decisions. "Operate" in this context means being actively involved in the day-to-day management.

c) Race/Ethnicity of Ownership (check one) based on definitions below.

Black Asian/Pacific or Asian/Indian Caucasian
 Hispanic Native American (American Indians, Eskimos, Aleuts and native Hawaiians)

ETHNIC GROUP DEFINITIONS

Black Americans: United States citizens whose origins are in any of the Black racial groups of Africa.
Hispanic Americans: United States citizens whose origins are in Mexico, Puerto Rico, Cuba, Portugal, Central or Central America.
Native Americans: United States citizens whose origins are in any of the original peoples of North America, i.e., American Indians, Eskimos, Aleuts and native Hawaiians.
Asian Pacific/Asian Indian Americans: United States citizens whose origins are in Japan, China, Korea, Taiwan, Cambodia, Laos, Vietnam, the Philippines, Samoa, Guam, the U.S. Trust Territories of the Pacific Islands, the Northern Mariana Islands, India, Pakistan, or Bangladesh.

I certify that the business classification and ethnicity indicated above reflects the true and correct status of this business in accordance with current Federal Small Business Administration criteria. I agree to inform Community High School District 99 immediately in writing of any changes to the information contained herein, including changes in ownership, controlling interest or operations. I understand that falsely certifying this information may result in suspension from participation in Community High School District 99 – 2021 Capital Projects North & South

Name: _____ Title: _____
(Print or Type)

Signature: _____ Date: _____

END OF SECTION 004101

BID DATE: February 18th at 10:00 a.m. (CST)
(via Building Connected)

BID TO: Community High School District 99
Administrative Center
6301 Springside Avenue
Downers Grove, IL 60516

RECEIVED BY:

BID FROM: _____

BID FOR: Bid Group 1 - Bid Package #04 - Painting
Transition Building
4232 Venard Road
Downers Grove, IL 60516

THE UNDERSIGNED:

Acknowledges receipt of:

Plans and specifications for the work indicated above.

Addenda: No. _____ dated _____
No. _____ dated _____
No. _____ dated _____
No. _____ dated _____

Having examined the site of the work, and having familiarized himself or herself with local conditions affecting the cost of the work and with all requirements of the bidding documents including Instructions to Bidders, drawings, specifications and duly issued addenda as prepared by the architect, Wight & Company, hereby agrees to perform all work and furnish all labor, material and equipment specifically required of him by the bidding documents and such additional work as may be included as related requirements in other divisions or sections of the specifications, exclusive of alternate bids.

Agrees:

To furnish and install the described material and/or services for stated lump sum price.

To hold this bid open until **90** calendar days after bid opening date.

To accept the provisions of the General Provisions (Project Manual Division 0 – Bidding & Contracting Requirements

Section 00201) and disposition of bid security.

To enter into and execute a contract with the Owner, if awarded on the basis of this bid, and in connection therewith to:

1. Furnish all bonds and insurance required by the bidding documents.
2. Accomplish the work in accordance with the contract.
3. Complete the work within the contract time herein specified.

Completion Time:

The undersigned agrees to begin construction immediately, or as directed by the Construction Manager, upon notice of contract award and to perform the following components of the work in accordance with the Construction Manager's Construction. This schedule is bound in the Project Manual. See attached scope of work in section 0300.

SCOPE OF WORK:

The work in this agreement (without additional compensation) shall include, but shall not necessarily be limited to, all skilled labor, supervision, premium time, materials, tools, equipment, plant, supplies, samples, shop drawings, design/engineering drawings, layout, transportation, supervision, contributions, insurance, taxes (if applicable), compliance with all agencies (City / Village, County, State, Federal and/or any other jurisdictional agency, as may be required) and/or all services and facilities necessary and/or required for the performance of all Work shown, detailed, and/or implied by the following documents and as defined herein.

It is understood that this Trade Contractor shall perform the Work for a complete and operational system as indicated or implied in all Contract Documents. It is recognized and understood that the documents upon which the bid is based are at a conceptual phase and this Contractor who has certain skills and judgments based upon his knowledge of techniques, procedures, systems, general state of the art of his specialty is expected to include in the scope of work, all items required in order to carry out a complete and functional system whether or not shown or described in the contract documents. This contract will be awarded on the basis of such documents with the understanding that this contractor is to furnish and install all items required for the proper completion of this work without adjustment to this contract price. No extra payments shall be made of claims entertained as a result of such items, unless it can be clearly demonstrated to be added scope to the contract and beyond the original intent of the documents.

Contractor to provide all Trade Contract work referenced in:

1. Any sheet of this bid group package including (reference Division 0 – Bidding and Contract Requirements, Section 00200 – Notice to Bidders).
2. Specification 00300 Bid Packages Scope Document.

WORK BASE BID: For providing all work including all allowances as required for the completion of the construction of the base bid project as shown on the drawings and specifications and NOT including alternate bids and/or contractor's proposed alternates and substitutes.

BASE BID

TOTAL BASE BID AMOUNT **TRANSITION BUILDING BUILD OUT:**

_____ Dollars (\$ _____)

1. This TRADE CONTRACTOR **shall include an allowance of \$10,000.00 in their base bid** to account for any unforeseen conditions. Contract amounts will be adjusted by change order for amounts greater or less than the allowance. Allowance to be utilized only at the direction of Construction Manager.

BONDS:

This TRADE CONTRACTOR will be required to provide a Performance and Payment Bond for their work in accordance with 00201 of the General Conditions.

Award Basis:

The project will be awarded based upon the attached Evaluation Criteria, Section 301a. Owner and Construction Manager alternate's may be considered to find the most qualified bidder if the result of combining the base bid and the selected alternate(s) is the most qualified bid, and is to the benefit of the owner.

Each of the following amounts for alternate construction includes the entire cost of such construction, except as otherwise noted. Acceptance of any or all of the alternates for inclusion in the contract is the sole prerogative of the owner.

All additional costs due to the alternates are included in the amount to be added to the base bid, so that no additional costs will be borne by the owner due to acceptance of alternates. This alternate price is not to be included in the base bid price.

Owner Requested Alternates:

Each of the following amounts for alternate construction includes the entire cost of such construction, except as otherwise noted. Acceptance of any or all of the alternates for inclusion in the contract is the sole prerogative of the owner.

All additional costs due to the alternates are included in the amount to be added to the base bid, so that no additional costs will be borne by the owner due to acceptance of alternates.

Proposed Alternates: (Contractors Proposed Alternates)

Item Specified	Proposed Alternate	Change in Bid Price
1. _____	_____	_____
2. _____	_____	_____
3. _____	_____	_____

Owner Requested Unit Prices/Allowances (as applicable to this Trade Contractor's scope of work) (additive or deductive).

This trade contractor includes _____ dumpsters for all refuse caused by this trade contractor's work in the amount of _____ Dollars (\$_____) Note: trade contractors are to include in their bid form submittal the quantity of dumpsters required to complete their work and the cost associated with same. Dumpster costs will be subtracted by change order. Dumpsters will be procured and managed by Construction Manager. Note: Dumpster use in excess of that proposed by this Trade Contractor will be adjusted by back charge.

Owner Requested Scheduling Information:

Note: The work of this Trade Contractor is to be completed in accordance with the overall project schedule as identified elsewhere in this project manual and/or as subsequently directed by Construction Manager. This Trade Contractor shall

submit a proposed submittals list/schedule/material log within five (5) calendar days of Notice To Proceed.

1. Shop drawings / Submittal for this trade contractor will be submitted within 10 calendar days of receipt of notice to proceed.

Bid Acceptance:

If written notice of the acceptance of this bid is mailed, telegraphed or delivered to the undersigned within the time noted herein, after the date of opening of bids or at any time thereafter before this bid is withdrawn, the undersigned agrees that he will execute a construction contract in accordance with the bids as accepted.

The Owner reserves the right to award the contract to its best interests, review and accept any and all value engineering alternatives, negotiate with the lowest responsible bidder, to reject any or all bids, to waive any informalities in bidding and to hold all bids for the bid guarantee period. The Owner reserves the right to award separate contracts for any of the items of work bid herein.

Bid Deposit:

The undersigned furnishes herewith, as required in the Instructions to Bidders, a bid deposit in the amount of ten percent (10%) of the amount bid in the form of Cashier's Check, or Certified Check, made payable to the Owner or Bid Bond, naming the Owner as obligee. (Bidder to check form of deposit furnished.)

It is understood and agreed that should the undersigned fail to enter into a contract with the Owner or furnish acceptable contract security within the time and in the manner herein provided, the bid deposit shall be retained by the Owner as liquidated damages and not as a forfeiture. As it is impossible to determine precisely an exact amount of damages the Owner will sustain, it is agreed that the bid deposit is a fair and equitable estimate of such damages.

REPRESENTATIONS AND CERTIFICATIONS:

The bidder makes the following representations and certifications as part of his bid on the project herein identified in the Bid Form. In the case of a joint venture bid, each party represents and certifies as to his own organization.

AVAILABILITY. The number and amount of contracts and awards pending which I am and/or will be obligated to perform, now and during the course of the project, will not interfere with or hinder the timely prosecution of my work.

SURETY. I have notified a Surety Company that I am submitting a bid for work to be performed on the project. The Surety Company has agreed to issue a performance and labor and material payment bond for my work, if my bid is accepted and the contract awarded to me.

INDEPENDENT PRICE DETERMINATION. The contract sum in this bid has been arrived at independently, without consultation, communication or agreement for the purpose of restricting competition.

PREVAILING WAGE. The contractor and each subcontractor shall pay not less than the general prevailing rate of hourly wages for work of a similar character in the locality in which the work is performed and not less than general prevailing rate of hourly wages for legal holidays and overtime work in the performance of work under this contract, as established by the Illinois Department of Labor, pursuant to an act of the General Assembly of the State of Illinois approved June 26, 1941 as amended according to Section 820 ILCS 130/1.

Pursuant to Section 820 ILCS 130/5, the contractor and each subcontractor shall keep an accurate record showing the names and occupation of all laborers, workers and mechanics employed by them, and also showing the actual hourly wages paid to each such individual, which record shall be open at all reasonable hours to inspection by the Owner, its officers and agents, and to agents of the Illinois Department of Labor.

The contractor and each subcontractor hereby agree, jointly and severally, to defend, indemnify and hold harmless the Owner from any and all claims, demands, liens or suits of any kind or nature whatsoever (including suits for injunctive relief) by the Illinois Department of Labor under the Illinois Prevailing Wage Act, Section 820 ILCS 130/1., or by any laborer, worker or mechanic employed by the contractor or the subcontractor who alleges that he has been paid for his services in a sum less than prevailing wage rates required by Illinois law. The Owner agrees to notify the contractor or subcontractor of the pendency of any such claim, demand, lien or suit.

By submitting a bid, each bidder agrees to waive any claim it has or may have against the Owner, the Architect, Engineer, Construction Manager and their respective employees, arising out of or in connection with the administration, evaluation, or recommendation of any bid; waiver of any requirements under the Bid Documents; or the Contract Document; acceptance or rejection of any bids; and award of the Contract.

Signature:

Respectfully submitted this _____ day _____, 2021

Type of Firm (Bidder to indicate)

_____ Individual

_____ Partnership

_____ Corporation

_____ Joint Venture

_____ Other

(CORPORATE SEAL)

(Firm Name)

(Address)

(Telephone Number)

(FAX)

(E-mail Address)

(Bidder's Signature)

(Title)

Subscribed and sworn to me
this . day of __, 2020

NOTE: All pages of this bid form must be returned with your proposal. Failure to do so shall disqualify your bid.

CERTIFICATE OF BIDDER ELIGIBILITY

720 ILCS 5/33E-11 REQUIRES THAT ALL CONTRACTORS BIDDING FOR PUBLIC AGENCIES IN THE State of Illinois certify that they are not barred from bidding on public contracts for bid rigging or bid rotation.

The following certification must be signed and submitted with bidder's bid proposal. FAILURE TO DO SO MAY RESULT IN DISQUALIFICATION OF THE BIDDER.

_____, as part of its bid for the _____ work for Community High School District 99, Downers Grove, Illinois, DuPage County, Illinois certified that said contractor is not barred from bidding on the aforementioned contract as a result of violation of either 720 ILCS 5/33E-3 or 720 ILCS 5/33-E4.

Firm: _____

By: _____
(Signature)

(Printed Name & Title)

SUBSCRIBED AND SWORN TO before me

This _____ day of _____, 202

NOTARY PUBLIC

**CRIMINAL CODE CERTIFICATION
AS REQUIRED BY:
STATE OF ILLINOIS CRIMINAL CODE OF 2012, 720 ILCS 5/33E-11**

I, _____ the individual whose signature appears below on this bid/contract
for _____ hereby certify that the bidding party/contracting party
is not barred from bidding on the contract as a result of a violation of either Section 33E-3 or Section 33E-4 of 720 ILCS 5/33E-3 or 5/33E-4 of the Illinois Compiled Statutes, as amended.

By: _____
Authorized Agent of Contractor (name and title)

SUBSCRIBED AND SWORN to before
me this ____ day _____, 20__.

Notary Public

EQUAL EMPLOYMENT OPPORTUNITY

Section I. This EQUAL EMPLOYMENT OPPORTUNITY CLAUSE is required by the Illinois Human Rights Act and the Rules and Regulations of the Illinois Department of Human Rights published at 44 Illinois Administrative Code Section 750, *et seq.*

Section II. In the event of the Contractor's noncompliance with any provision of this Equal Employment Opportunity Clause, the Illinois Human Rights Act, or the Rules and Regulations of the Department of Human Rights (hereinafter referred to as the Department) the Contractor may be declared ineligible for future contracts or subcontracts with the State of Illinois or any of its political subdivisions or municipal corporations, and this Contract may be canceled or voided in whole or in part, and other sanctions or penalties may be imposed or remedies involved as provided by statute or regulation.

During the performance of this Agreement, the Contractor agrees:

A. That it will not discriminate against any employee or applicant for employment because of race, color, religion, sex, sexual orientation, national origin or ancestry, citizenship status, age, physical or mental disability unrelated to ability, military status or an unfavorable discharge from military service; and further that it will examine all job classifications to determine if minority persons or women are underutilized and will take appropriate affirmative action to rectify any such underutilization.

B. That, if it hires additional employees in order to perform this Contract, or any portion hereof, it will determine the availability (in accordance with the Department's Rules and Regulations) of minorities and women in the area(s) from which it may reasonably recruit and it will hire for each job classification for which employees are hired in such a way that minorities and women are not underutilized.

C. That, in all solicitations or advertisements for employees placed by it or on its behalf, it will state that all applicants will be afforded equal opportunity without discrimination because of race, color, religion, sex, sexual orientation, marital status, national origin or ancestry, citizenship status, age, or physical or mental handicap unrelated to ability, military status or an unfavorable discharge from military service.

D. That it will send to each labor organization or representative of workers with which it has or is bound by a collective bargaining or other agreement or understanding, a notice advising such labor organization or representative of the Vendor's obligations under the Illinois Human Rights Act and Department's Rules and Regulations. If any labor organization or representative fails or refuses to cooperate with the Contractor in its efforts to comply with the Act and Rules and Regulations, the Contractor will promptly notify the Department and the contracting agency and will recruit employees from other sources when necessary to fulfill its obligations under the Contract.

E. That it will submit reports as required by the Department's Rules and Regulations, furnish all relevant information as may from time to time be requested by the Department or the contracting agency, and in all respects comply with the Illinois Human Rights Act and Department's Rules and Regulations.

F. That it will permit access to all relevant books, records, accounts and work sites by personnel of the contracting agency and Department for purposes of investigation to ascertain compliance with the Illinois Human Rights Act and Department's Rules and Regulations.

G. That it will include verbatim or by reference the provisions of this Equal Employment Opportunity Clause in every subcontract it awards under which any portion of this Contract obligations are undertaken or assumed, so that such provisions will be binding upon such subcontractor. In the same manner as the other provisions of this Agreement, the Contractor will be liable for compliance with applicable provisions of this clause by such subcontractors; and further it will promptly notify the contracting agency and the Department in the event any subcontractor fails or refuses to comply therewith. In addition, the Contractor will not utilize any subcontractor declared by the Illinois Human Rights Department to be ineligible for contracts or subcontracts with the State of Illinois or any of its political subdivisions or municipal corporations.

ACKNOWLEDGED AND AGREED TO:

By: _____
Authorized Agent of Contractor (name and title)

DATE: _____

SEXUAL HARASSMENT POLICY

_____, having submitted a bid for _____ (Name of Contractor)
_____ to Community High School District No. 00, hereby certifies that
said contractor has a written sexual harassment policy in place in full compliance with 775 ILCS 5/2-105 (A) (4).

By: _____
Authorized Agent of Contractor (name and title)

SUBSCRIBED AND SWORN to before
me this ____ day _____, 20__.

Notary Public

TAX CERTIFICATION

I, _____, having been first duly sworn depose and state as follows:

I, _____, am the duly authorized agent for
High School District No. 99 for

_____ and I hereby certify that _____ is not delinquent in the payment of any tax administered by the Illinois Department of Revenue, or if it is:

a. it is contesting its liability for the tax or the amount of tax in accordance with procedures established by the appropriate Revenue Act; or

b. it has entered into an agreement with the Department of Revenue for payment of all taxes due and is currently in compliance with that agreement.

By: _____
Authorized Agent of Contractor (name and title)

SUBSCRIBED AND SWORN to before
me this ____ day _____, 20__.

Notary Public

SUBSTANCE ABUSE PREVENTION ON PUBLIC WORKS PROJECTS

The Contractor certifies that it has in place a written program that meets or exceeds the program requirements of the Substance Abuse Prevention on Public Works Projects Act (Public Act 95-0635), and will provide a copy thereof to Community High School District No. 99 prior to commencement of work on the Project.

By: _____
Authorized Agent of Contractor (name and title)

SUBSCRIBED AND SWORN to before
me this ____ day _____, 20__.

Notary Public

**CERTIFICATE REGARDING
EMPLOYMENT OF ILLINOIS WORKERS ON PUBLIC WORKS**

_____ agrees if at the time the Agreement is executed, or if during the term of the Agreement, there is excessive unemployment in Illinois as defined in the Employment of Illinois Workers on Public Works Act, 30- ILCS 570/0/01 et seq., as two consecutive months of unemployment exceeding 5%, then _____ agrees to employ Illinois laborers in accordance with the Employment of Illinois Workers on Public Works Act. An "Illinois laborer" is defined as any person who has resided in Illinois for at least thirty (30) days and intends to become or remain an Illinois resident.

Firm: _____

By: _____
(Signature)

(Printed Name & Title)

SUBSCRIBED AND SWORN TO before me

This _____ day of _____, 2021

NOTARY PUBLIC

PREVAILING WAGE AFFIDAVIT

AFFIDAVIT: "I (we) hereby certify and affirm that if awarded a contract with Community High School District 99, we will comply fully with the "Illinois Prevailing Wage Act (Ill. Rev. Stat., 1987 Ch. 48, Sections 398 s-1-12 as amended by Public Act 86-693 and 86-799 effected January 1, 1990, and any other amendments effective thereafter)". We further understand that current prevailing wage standards are included in the Supplementary General Conditions.

The following affidavit must be signed and submitted with bidder's bid proposal. FAILURE TO DO SO MAY RESULT IN DISQUALIFICATION OF THE BIDDER.

_____, as part of its bid for the _____ work for Community High School District 99, Downers Grove, Illinois, certifies that said contractor is not barred from bidding on the aforementioned contract as a result of a violation of the Illinois Prevailing Wage Act (Ill. Rev. Stat., 1987 Ch. 48, Sections 398 s-1-12 as amended by Public Act 86-693 and 86-799 effected January 1, 1990).

Firm: _____

By: _____
(Signature)

(Printed Name & Title)

SUBSCRIBED AND SWORN TO before me

This _____ day of _____, 2021

NOTARY PUBLIC

NON-COLLUSION AFFIDAVIT

AFFIDAVIT: "I (we) hereby certify and affirm that my (our) proposal was prepared independently for this project and that it contains no fees or amounts other than that for the legitimate execution of this work as specified and that it includes no understanding or agreements in restraint of trade."

The following affidavit must be signed and submitted with bidder's bid proposal.
FAILURE TO DO SO MAY RESULT IN DISQUALIFICATION OF THE BIDDER.

_____, as a part of its bid for the _____ work for Community High School District 99, Downers Grove, Illinois, certifies that said Contractor is not barred from bidding on the aforementioned contract as a result of a violation of the above Non-Collusion Affidavit.

Firm: _____

By: _____
(Signature)

(Printed Name & Title)

SUBSCRIBED AND SWORN TO before me

This _____ day of _____, 2021

NOTARY PUBLIC

Criminal Background Investigations

Contractor hereby represents, warrants and certified that no officer or director thereof has any knowledge that any employee thereof has been convicted of committing or attempting to commit "Criminal Code of 1961," 720 ILCS, Sections 5/11-6 (Indecent solicitation of a child), 5/11-9 (Public indecency), 5/11-14 (Prostitution), 5/11-15 (Soliciting for a prostitute), 5/11-15.1 (Soliciting for a juvenile prostitute), 5/11-19 (Pimping), 5/11-19.1 (Juvenile pimping), 5/11-19.2 (Exploitation of a child), 5/11-20 (Obscenity), 5/11-20.1 (Sexual assault), 5/12-14 (Aggravated criminal sexual assault), 5/12-15 (Criminal sexual abuse), and 5/120-16 (Aggravated criminal sexual abuse), and/or those offenses defined in the "Cannabis Control Act," 720 ILCS, 550/1 et seq. (except the "Illinois Controlled Substances Act," 720 ILCS 570/100 et seq. and/or any offense committed or attempted in any other state or against the laws of the United States, which if committed or attempted in this State, would have been punishable as one or more of the foregoing offenses.

Contractor further agrees that it shall not employ any person who have or may have direct, daily contact with the pupils of any school in the district, and for whom a criminal background investigation has not been conducted pursuant hereto, and further represents and agrees that all applicants for any such employment shall furnish with their applications the attached written "Authorization for Criminal Background Information" form authorizing the Board of Education to request a criminal background investigation of said applicant pursuant to Section 5/10-21.9 of the School Code of Illinois and to receive criminal history record information pursuant thereto to determine if the applicant has been convicted of committing or attempting to commit any of the criminal or drug offenses enumerated above. Contractor further agrees to submit with said authorization payment for any costs and expenses associated with the criminal background investigation.

Contractor further represents, warrants, and certifies that no applicant for employment with respect to whom the criminal investigation reveals any conviction for committing and/or attempting to commit any of the above enumerated offenses shall be employed thereby in any position that involves or may involve contact with the students of the school district.

This certification is executed on the date hereinafter indicated by the designated contractor by its duly authorized officer.

Firm: _____

By: _____
(Signature)

(Printed Name & Title)

Date: _____

Criminal Background Investigation

The undersigned hereby authorizes in Board of Education of Community High School District 99, Downers Grove, Illinois, to request a criminal background investigation from the Illinois State Police, pursuant to Section 5/10-21.9 of the School Code of Illinois, 105 ILCS 5/10-21.9 and to receive criminal history record information pursuant thereto.

By: _____
(Signature of Applicant of Employee)

(Printed or Typed Name of Applicant Employee)

Date: _____

BUSINESS CLASSIFICATION

a) Business Entity (check one)

Corporation (Publicly held)* Not-for-Profit* Government Agency/Public Institution*
 Corporation (Privately held) Partnership Sole Proprietor

* If checked, do not complete section III (b) and (c) below.

b) Business Ownership (check one) If minority or woman owned, attach copy of certification evidence.

Large Business: Male Owned Woman Owned
Small Business: Male Owned Woman Owned

BUSINESS DEFINITIONS

Small Business Concern - an independently owned and operated concern certified, or certifiable, as a small business by the Federal Small Business Administration (SBA). Standard Industrial Classification (SIC) codes may be found in the Federal Acquisition Regulations, Section 19.102 or in the Federal Procurement Regulations, Section 1-1.701.

Small Disadvantaged or Minority Business Concern - a small business concern which is at least fifty-one percent (51%) owned by one or more socially and economically disadvantaged individuals or in the case of any publicly owned business, at least fifty-one percent (51%) of the stock of which is owned by such individuals; and whose management and daily business operations are controlled by one or more of such individuals. Business owners who certify that they are members of named groups (Black Americans, Hispanic Americans, Native Americans, Asian-Pacific Americans) are considered socially and economically disadvantaged.

Woman-Owned Business - a business concern that is at least fifty-one percent (51%) owned by a woman or women who also control and operate it. "Control" in this context means exercising the power to make policy decisions. "Operate" in this context means being actively involved in the day-to-day management.

c) Race/Ethnicity of Ownership (check one) based on definitions below.

Black Asian/Pacific or Asian/Indian Caucasian
 Hispanic Native American (American Indians, Eskimos, Aleuts and native Hawaiians)

ETHNIC GROUP DEFINITIONS

Black Americans: United States citizens whose origins are in any of the Black racial groups of Africa.
Hispanic Americans: United States citizens whose origins are in Mexico, Puerto Rico, Cuba, Portugal, Central or Central America.
Native Americans: United States citizens whose origins are in any of the original peoples of North America, i.e., American Indians, Eskimos, Aleuts and native Hawaiians.
Asian Pacific/Asian Indian Americans: United States citizens whose origins are in Japan, China, Korea, Taiwan, Cambodia, Laos, Vietnam, the Philippines, Samoa, Guam, the U.S. Trust Territories of the Pacific Islands, the Northern Mariana Islands, India, Pakistan, or Bangladesh.

I certify that the business classification and ethnicity indicated above reflects the true and correct status of this business in accordance with current Federal Small Business Administration criteria. I agree to inform Community High School District 99 immediately in writing of any changes to the information contained herein, including changes in ownership, controlling interest or operations. I understand that falsely certifying this information may result in suspension from participation in Community High School District 99 – 2021 Capital Projects North & South

Name: _____ Title: _____
(Print or Type)

Signature: _____ Date: _____

END OF SECTION 004101

BID DATE: February 18th at 10:00 a.m. (CST)
(via Building Connected)

BID TO: Community High School District 99
Administrative Center
6301 Springside Avenue
Downers Grove, IL 60516

RECEIVED BY:

BID FROM: _____

BID FOR: Bid Group 1 - Bid Package #05 - Flooring
Transition Building
4232 Venard Road
Downers Grove, IL 60516

THE UNDERSIGNED:

Acknowledges receipt of:

Plans and specifications for the work indicated above.

Addenda: No. _____ dated _____
No. _____ dated _____
No. _____ dated _____
No. _____ dated _____

Having examined the site of the work, and having familiarized himself or herself with local conditions affecting the cost of the work and with all requirements of the bidding documents including Instructions to Bidders, drawings, specifications and duly issued addenda as prepared by the architect, Wight & Company, hereby agrees to perform all work and furnish all labor, material and equipment specifically required of him by the bidding documents and such additional work as may be included as related requirements in other divisions or sections of the specifications, exclusive of alternate bids.

Agrees:

To furnish and install the described material and/or services for stated lump sum price.

To hold this bid open until **90** calendar days after bid opening date.

To accept the provisions of the General Provisions (Project Manual Division 0 – Bidding & Contracting Requirements

Section 00201) and disposition of bid security.

To enter into and execute a contract with the Owner, if awarded on the basis of this bid, and in connection therewith to:

1. Furnish all bonds and insurance required by the bidding documents.
2. Accomplish the work in accordance with the contract.
3. Complete the work within the contract time herein specified.

Completion Time:

The undersigned agrees to begin construction immediately, or as directed by the Construction Manager, upon notice of contract award and to perform the following components of the work in accordance with the Construction Manager's Construction. This schedule is bound in the Project Manual. See attached scope of work in section 0300.

SCOPE OF WORK:

The work in this agreement (without additional compensation) shall include, but shall not necessarily be limited to, all skilled labor, supervision, premium time, materials, tools, equipment, plant, supplies, samples, shop drawings, design/engineering drawings, layout, transportation, supervision, contributions, insurance, taxes (if applicable), compliance with all agencies (City / Village, County, State, Federal and/or any other jurisdictional agency, as may be required) and/or all services and facilities necessary and/or required for the performance of all Work shown, detailed, and/or implied by the following documents and as defined herein.

It is understood that this Trade Contractor shall perform the Work for a complete and operational system as indicated or implied in all Contract Documents. It is recognized and understood that the documents upon which the bid is based are at a conceptual phase and this Contractor who has certain skills and judgments based upon his knowledge of techniques, procedures, systems, general state of the art of his specialty is expected to include in the scope of work, all items required in order to carry out a complete and functional system whether or not shown or described in the contract documents. This contract will be awarded on the basis of such documents with the understanding that this contractor is to furnish and install all items required for the proper completion of this work without adjustment to this contract price. No extra payments shall be made of claims entertained as a result of such items, unless it can be clearly demonstrated to be added scope to the contract and beyond the original intent of the documents.

Contractor to provide all Trade Contract work referenced in:

1. Any sheet of this bid group package including (reference Division 0 – Bidding and Contract Requirements, Section 00200 – Notice to Bidders).
2. Specification 00300 Bid Packages Scope Document.

WORK BASE BID: For providing all work including all allowances as required for the completion of the construction of the base bid project as shown on the drawings and specifications and NOT including alternate bids and/or contractor's proposed alternates and substitutes.

BASE BID

TOTAL BASE BID AMOUNT **TRANSITION BUILDING BUILD OUT:**

_____ Dollars (\$ _____)

1. This TRADE CONTRACTOR **shall include an allowance of \$30,000.00 in their base bid** to account for any unforeseen conditions. Contract amounts will be adjusted by change order for amounts greater or less than the allowance. Allowance to be utilized only at the direction of Construction Manager.

BONDS:

This TRADE CONTRACTOR will be required to provide a Performance and Payment Bond for their work in accordance with 00201 of the General Conditions.

Award Basis:

The project will be awarded based upon the attached Evaluation Criteria, Section 301a. Owner and Construction Manager alternate's may be considered to find the most qualified bidder if the result of combining the base bid and the selected alternate(s) is the most qualified bid, and is to the benefit of the owner.

Each of the following amounts for alternate construction includes the entire cost of such construction, except as otherwise noted. Acceptance of any or all of the alternates for inclusion in the contract is the sole prerogative of the owner.

All additional costs due to the alternates are included in the amount to be added to the base bid, so that no additional costs will be borne by the owner due to acceptance of alternates. This alternate price is not to be included in the base bid price.

Owner Requested Alternates:

Each of the following amounts for alternate construction includes the entire cost of such construction, except as otherwise noted. Acceptance of any or all of the alternates for inclusion in the contract is the sole prerogative of the owner.

All additional costs due to the alternates are included in the amount to be added to the base bid, so that no additional costs will be borne by the owner due to acceptance of alternates.

Proposed Alternates: (Contractors Proposed Alternates)

	Item Specified	Proposed Alternate	Change in Bid Price
1.	_____	_____	_____
2.	_____	_____	_____
3.	_____	_____	_____

Owner Requested Unit Prices/Allowances (as applicable to this Trade Contractor's scope of work) (additive or deductive).

required to complete their work and the cost associated with same. Dumpster costs will be subtracted by change order. Dumpsters will be procured and managed by Construction Manager. Note: Dumpster use in excess of that proposed by this Trade Contractor will be adjusted by back charge.

Owner Requested Scheduling Information:

Note: The work of this Trade Contractor is to be completed in accordance with the overall project schedule as identified elsewhere in this project manual and/or as subsequently directed by Construction Manager. This Trade Contractor shall submit a proposed submittals list/schedule/material log within five (5) calendar days of Notice To Proceed.

1. Shop drawings / Submittal for this trade contractor will be submitted within 10 calendar days of receipt of notice to proceed.

Bid Acceptance:

If written notice of the acceptance of this bid is mailed, telegraphed or delivered to the undersigned within the time noted herein, after the date of opening of bids or at any time thereafter before this bid is withdrawn, the undersigned agrees that he will execute a construction contract in accordance with the bids as accepted.

The Owner reserves the right to award the contract to its best interests, review and accept any and all value engineering alternatives, negotiate with the lowest responsible bidder, to reject any or all bids, to waive any informalities in bidding and to hold all bids for the bid guarantee period. The Owner reserves the right to award separate contracts for any of the items of work bid herein.

Bid Deposit:

The undersigned furnishes herewith, as required in the Instructions to Bidders, a bid deposit in the amount of ten percent (10%) of the amount bid in the form of Cashier's Check, or Certified Check, made payable to the Owner or Bid Bond, naming the Owner as obligee. (Bidder to check form of deposit furnished.)

It is understood and agreed that should the undersigned fail to enter into a contract with the Owner or furnish acceptable contract security within the time and in the manner herein provided, the bid deposit shall be retained by the Owner as liquidated damages and not as a forfeiture. As it is impossible to determine precisely an exact amount of damages the Owner will sustain, it is agreed that the bid deposit is a fair and equitable estimate of such damages.

REPRESENTATIONS AND CERTIFICATIONS:

The bidder makes the following representations and certifications as part of his bid on the project herein identified in the Bid Form. In the case of a joint venture bid, each party represents and certifies as to his own organization.

AVAILABILITY. The number and amount of contracts and awards pending which I am and/or will be obligated to perform, now and during the course of the project, will not interfere with or hinder the timely prosecution of my work.

SURETY. I have notified a Surety Company that I am submitting a bid for work to be performed on the project. The Surety Company has agreed to issue a performance and labor and material payment bond for my work, if my bid is accepted and the contract awarded to me.

INDEPENDENT PRICE DETERMINATION. The contract sum in this bid has been arrived at independently, without consultation, communication or agreement for the purpose of restricting competition.

PREVAILING WAGE. The contractor and each subcontractor shall pay not less than the general prevailing rate of hourly wages for work of a similar character in the locality in which the work is performed and not less than general prevailing rate of hourly wages for legal holidays and overtime work in the performance of work under this contract, as established by the Illinois Department of Labor, pursuant to an act of the General Assembly of the State of Illinois approved June 26, 1941 as amended according to Section 820 ILCS 130/1.

Pursuant to Section 820 ILCS 130/5, the contractor and each subcontractor shall keep an accurate record showing the names and occupation of all laborers, workers and mechanics employed by them, and also showing the actual hourly wages paid to each such individual, which record shall be open at all reasonable hours to inspection by the Owner, its officers and agents, and to agents of the Illinois Department of Labor.

The contractor and each subcontractor hereby agree, jointly and severally, to defend, indemnify and hold harmless the Owner from any and all claims, demands, liens or suits of any kind or nature whatsoever (including suits for injunctive relief) by the Illinois Department of Labor under the Illinois Prevailing Wage Act, Section 820 ILCS 130/1., or by any laborer, worker or mechanic employed by the contractor or the subcontractor who alleges that he has been paid for his services in a sum less

than prevailing wage rates required by Illinois law. The Owner agrees to notify the contractor or subcontractor of the pendency of any such claim, demand, lien or suit.

By submitting a bid, each bidder agrees to waive any claim it has or may have against the Owner, the Architect, Engineer, Construction Manager and their respective employees, arising out of or in connection with the administration, evaluation, or recommendation of any bid; waiver of any requirements under the Bid Documents; or the Contract Document; acceptance or rejection of any bids; and award of the Contract.

Signature:

Respectfully submitted this _____ day _____, 2021

Type of Firm (Bidder to indicate)

_____ Individual

_____ Partnership

_____ Corporation

_____ Joint Venture

_____ Other

(CORPORATE SEAL)

(Firm Name)

(Address)

(Telephone Number)

(FAX)

(E-mail Address)

(Bidder's Signature)

(Title)

Subscribed and sworn to me
this . day of __, 2020

NOTE: All pages of this bid form must be returned with your proposal. Failure to do so shall disqualify your bid.

CERTIFICATE OF BIDDER ELIGIBILITY

720 ILCS 5/33E-11 REQUIRES THAT ALL CONTRACTORS BIDDING FOR PUBLIC AGENCIES IN THE State of Illinois certify that they are not barred from bidding on public contracts for bid rigging or bid rotation.

The following certification must be signed and submitted with bidder's bid proposal. FAILURE TO DO SO MAY RESULT IN DISQUALIFICATION OF THE BIDDER.

_____, as part of its bid for the _____ work for Community High School District 99, Downers Grove, Illinois, DuPage County, Illinois certified that said contractor is not barred from bidding on the aforementioned contract as a result of violation of either 720 ILCS 5/33E-3 or 720 ILCS 5/33-E4.

Firm: _____

By: _____
(Signature)

(Printed Name & Title)

SUBSCRIBED AND SWORN TO before me

This _____ day of _____, 202

NOTARY PUBLIC

**CRIMINAL CODE CERTIFICATION
AS REQUIRED BY:
STATE OF ILLINOIS CRIMINAL CODE OF 2012, 720 ILCS 5/33E-11**

I, _____ the individual whose signature appears below on this bid/contract
for _____ hereby certify that the bidding party/contracting party
is not barred from bidding on the contract as a result of a violation of either Section 33E-3 or Section 33E-4 of 720 ILCS 5/33E-3 or 5/33E-4 of the Illinois Compiled Statutes, as amended.

By: _____
Authorized Agent of Contractor (name and title)

SUBSCRIBED AND SWORN to before
me this ____ day _____, 20__.

Notary Public

EQUAL EMPLOYMENT OPPORTUNITY

Section I. This EQUAL EMPLOYMENT OPPORTUNITY CLAUSE is required by the Illinois Human Rights Act and the Rules and Regulations of the Illinois Department of Human Rights published at 44 Illinois Administrative Code Section 750, *et seq.*

Section II. In the event of the Contractor's noncompliance with any provision of this Equal Employment Opportunity Clause, the Illinois Human Rights Act, or the Rules and Regulations of the Department of Human Rights (hereinafter referred to as the Department) the Contractor may be declared ineligible for future contracts or subcontracts with the State of Illinois or any of its political subdivisions or municipal corporations, and this Contract may be canceled or voided in whole or in part, and other sanctions or penalties may be imposed or remedies involved as provided by statute or regulation.

During the performance of this Agreement, the Contractor agrees:

A. That it will not discriminate against any employee or applicant for employment because of race, color, religion, sex, sexual orientation, national origin or ancestry, citizenship status, age, physical or mental disability unrelated to ability, military status or an unfavorable discharge from military service; and further that it will examine all job classifications to determine if minority persons or women are underutilized and will take appropriate affirmative action to rectify any such underutilization.

B. That, if it hires additional employees in order to perform this Contract, or any portion hereof, it will determine the availability (in accordance with the Department's Rules and Regulations) of minorities and women in the area(s) from which it may reasonably recruit and it will hire for each job classification for which employees are hired in such a way that minorities and women are not underutilized.

C. That, in all solicitations or advertisements for employees placed by it or on its behalf, it will state that all applicants will be afforded equal opportunity without discrimination because of race, color, religion, sex, sexual orientation, marital status, national origin or ancestry, citizenship status, age, or physical or mental handicap unrelated to ability, military status or an unfavorable discharge from military service.

D. That it will send to each labor organization or representative of workers with which it has or is bound by a collective bargaining or other agreement or understanding, a notice advising such labor organization or representative of the Vendor's obligations under the Illinois Human Rights Act and Department's Rules and Regulations. If any labor organization or representative fails or refuses to cooperate with the Contractor in its efforts to comply with the Act and Rules and Regulations, the Contractor will promptly notify the Department and the contracting agency and will recruit employees from other sources when necessary to fulfill its obligations under the Contract.

E. That it will submit reports as required by the Department's Rules and Regulations, furnish all relevant information as may from time to time be requested by the Department or the contracting agency, and in all respects comply with the Illinois Human Rights Act and Department's Rules and Regulations.

F. That it will permit access to all relevant books, records, accounts and work sites by personnel of the contracting agency and Department for purposes of investigation to ascertain compliance with the Illinois Human Rights Act and Department's Rules and Regulations.

G. That it will include verbatim or by reference the provisions of this Equal Employment Opportunity Clause in every subcontract it awards under which any portion of this Contract obligations are undertaken or assumed, so that such provisions will be binding upon such subcontractor. In the same manner as the other provisions of this Agreement, the Contractor will be liable for compliance with applicable provisions of this clause by such subcontractors; and further it will promptly notify the contracting agency and the Department in the event any subcontractor fails or refuses to comply therewith. In addition, the Contractor will not utilize any subcontractor declared by the Illinois Human Rights Department to be ineligible for contracts or subcontracts with the State of Illinois or any of its political subdivisions or municipal corporations.

ACKNOWLEDGED AND AGREED TO:

By: _____
Authorized Agent of Contractor (name and title)

DATE: _____

SEXUAL HARASSMENT POLICY

_____, having submitted a bid for _____ (Name of Contractor)
_____ to Community High School District No. 00, hereby certifies that
said contractor has a written sexual harassment policy in place in full compliance with 775 ILCS 5/2-105 (A) (4).

By: _____
Authorized Agent of Contractor (name and title)

SUBSCRIBED AND SWORN to before
me this ____ day _____, 20__.

Notary Public

TAX CERTIFICATION

I, _____, having been first duly sworn depose and state as follows:

I, _____, am the duly authorized agent for
High School District No. 99 for

_____ and I hereby certify that _____ is not delinquent in the payment of any tax administered by the Illinois Department of Revenue, or if it is:

a. it is contesting its liability for the tax or the amount of tax in accordance with procedures established by the appropriate Revenue Act; or

b. it has entered into an agreement with the Department of Revenue for payment of all taxes due and is currently in compliance with that agreement.

By: _____
Authorized Agent of Contractor (name and title)

SUBSCRIBED AND SWORN to before
me this ____ day _____, 20__.

Notary Public

SUBSTANCE ABUSE PREVENTION ON PUBLIC WORKS PROJECTS

The Contractor certifies that it has in place a written program that meets or exceeds the program requirements of the Substance Abuse Prevention on Public Works Projects Act (Public Act 95-0635), and will provide a copy thereof to Community High School District No. 99 prior to commencement of work on the Project.

By: _____
Authorized Agent of Contractor (name and title)

SUBSCRIBED AND SWORN to before
me this ____ day _____, 20__.

Notary Public

**CERTIFICATE REGARDING
EMPLOYMENT OF ILLINOIS WORKERS ON PUBLIC WORKS**

_____ agrees if at the time the Agreement is executed, or if during the term of the Agreement, there is excessive unemployment in Illinois as defined in the Employment of Illinois Workers on Public Works Act, 30- ILCS 570/0/01 et seq., as two consecutive months of unemployment exceeding 5%, then _____ agrees to employ Illinois laborers in accordance with the Employment of Illinois Workers on Public Works Act. An "Illinois laborer" is defined as any person who has resided in Illinois for at least thirty (30) days and intends to become or remain an Illinois resident.

Firm: _____

By: _____
(Signature)

(Printed Name & Title)

SUBSCRIBED AND SWORN TO before me

This _____ day of _____, 2021

NOTARY PUBLIC

PREVAILING WAGE AFFIDAVIT

AFFIDAVIT: "I (we) hereby certify and affirm that if awarded a contract with Community High School District 99, we will comply fully with the "Illinois Prevailing Wage Act (Ill. Rev. Stat., 1987 Ch. 48, Sections 398 s-1-12 as amended by Public Act 86-693 and 86-799 effected January 1, 1990, and any other amendments effective thereafter)". We further understand that current prevailing wage standards are included in the Supplementary General Conditions.

The following affidavit must be signed and submitted with bidder's bid proposal. FAILURE TO DO SO MAY RESULT IN DISQUALIFICATION OF THE BIDDER.

_____, as part of its bid for the _____ work for Community High School District 99, Downers Grove, Illinois, certifies that said contractor is not barred from bidding on the aforementioned contract as a result of a violation of the Illinois Prevailing Wage Act (Ill. Rev. Stat., 1987 Ch. 48, Sections 398 s-1-12 as amended by Public Act 86-693 and 86-799 effected January 1, 1990).

Firm: _____

By: _____
(Signature)

(Printed Name & Title)

SUBSCRIBED AND SWORN TO before me

This _____ day of _____, 2021

NOTARY PUBLIC

NON-COLLUSION AFFIDAVIT

AFFIDAVIT: "I (we) hereby certify and affirm that my (our) proposal was prepared independently for this project and that it contains no fees or amounts other than that for the legitimate execution of this work as specified and that it includes no understanding or agreements in restraint of trade."

The following affidavit must be signed and submitted with bidder's bid proposal.
FAILURE TO DO SO MAY RESULT IN DISQUALIFICATION OF THE BIDDER.

_____, as a part of its bid for the _____ work for Community High School District 99, Downers Grove, Illinois, certifies that said Contractor is not barred from bidding on the aforementioned contract as a result of a violation of the above Non-Collusion Affidavit.

Firm: _____

By: _____
(Signature)

(Printed Name & Title)

SUBSCRIBED AND SWORN TO before me

This _____ day of _____, 2021

NOTARY PUBLIC

Criminal Background Investigations

Contractor hereby represents, warrants and certified that no officer or director thereof has any knowledge that any employee thereof has been convicted of committing or attempting to commit "Criminal Code of 1961," 720 ILCS, Sections 5/11-6 (Indecent solicitation of a child), 5/11-9 (Public indecency), 5/11-14 (Prostitution), 5/11-15 (Soliciting for a prostitute), 5/11-15.1 (Soliciting for a juvenile prostitute), 5/11-19 (Pimping), 5/11-19.1 (Juvenile pimping), 5/11-19.2 (Exploitation of a child), 5/11-20 (Obscenity), 5/11-20.1 (Sexual assault), 5/12-14 (Aggravated criminal sexual assault), 5/12-15 (Criminal sexual abuse), and 5/120-16 (Aggravated criminal sexual abuse), and/or those offenses defined in the "Cannabis Control Act," 720 ILCS, 550/1 et seq. (except the "Illinois Controlled Substances Act," 720 ILCS 570/100 et seq. and/or any offense committed or attempted in any other state or against the laws of the United States, which if committed or attempted in this State, would have been punishable as one or more of the foregoing offenses.

Contractor further agrees that it shall not employ any person who have or may have direct, daily contact with the pupils of any school in the district, and for whom a criminal background investigation has not been conducted pursuant hereto, and further represents and agrees that all applicants for any such employment shall furnish with their applications the attached written "Authorization for Criminal Background Information" form authorizing the Board of Education to request a criminal background investigation of said applicant pursuant to Section 5/10-21.9 of the School Code of Illinois and to receive criminal history record information pursuant thereto to determine if the applicant has been convicted of committing or attempting to commit any of the criminal or drug offenses enumerated above. Contractor further agrees to submit with said authorization payment for any costs and expenses associated with the criminal background investigation.

Contractor further represents, warrants, and certifies that no applicant for employment with respect to whom the criminal investigation reveals any conviction for committing and/or attempting to commit any of the above enumerated offenses shall be employed thereby in any position that involves or may involve contact with the students of the school district.

This certification is executed on the date hereinafter indicated by the designated contractor by its duly authorized officer.

Firm: _____

By: _____
(Signature)

(Printed Name & Title)

Date: _____

Criminal Background Investigation

The undersigned hereby authorizes in Board of Education of Community High School District 99, Downers Grove, Illinois, to request a criminal background investigation from the Illinois State Police, pursuant to Section 5/10-21.9 of the School Code of Illinois, 105 ILCS 5/10-21.9 and to receive criminal history record information pursuant thereto.

By: _____
(Signature of Applicant of Employee)

(Printed or Typed Name of Applicant Employee)

Date: _____

BUSINESS CLASSIFICATION

a) Business Entity (check one)

Corporation (Publicly held)* Not-for-Profit* Government Agency/Public Institution*
 Corporation (Privately held) Partnership Sole Proprietor

* If checked, do not complete section III (b) and (c) below.

b) Business Ownership (check one) If minority or woman owned, attach copy of certification evidence.

Large Business: Male Owned Woman Owned
Small Business: Male Owned Woman Owned

BUSINESS DEFINITIONS

Small Business Concern - an independently owned and operated concern certified, or certifiable, as a small business by the Federal Small Business Administration (SBA). Standard Industrial Classification (SIC) codes may be found in the Federal Acquisition Regulations, Section 19.102 or in the Federal Procurement Regulations, Section 1-1.701.

Small Disadvantaged or Minority Business Concern - a small business concern which is at least fifty-one percent (51%) owned by one or more socially and economically disadvantaged individuals or in the case of any publicly owned business, at least fifty-one percent (51%) of the stock of which is owned by such individuals; and whose management and daily business operations are controlled by one or more of such individuals. Business owners who certify that they are members of named groups (Black Americans, Hispanic Americans, Native Americans, Asian-Pacific Americans) are considered socially and economically disadvantaged.

Woman-Owned Business - a business concern that is at least fifty-one percent (51%) owned by a woman or women who also control and operate it. "Control" in this context means exercising the power to make policy decisions. "Operate" in this context means being actively involved in the day-to-day management.

c) Race/Ethnicity of Ownership (check one) based on definitions below.

Black Asian/Pacific or Asian/Indian Caucasian
 Hispanic Native American (American Indians, Eskimos, Aleuts and native Hawaiians)

ETHNIC GROUP DEFINITIONS

Black Americans: United States citizens whose origins are in any of the Black racial groups of Africa.
Hispanic Americans: United States citizens whose origins are in Mexico, Puerto Rico, Cuba, Portugal, Central or Central America.
Native Americans: United States citizens whose origins are in any of the original peoples of North America, i.e., American Indians, Eskimos, Aleuts and native Hawaiians.
Asian Pacific/Asian Indian Americans: United States citizens whose origins are in Japan, China, Korea, Taiwan, Cambodia, Laos, Vietnam, the Philippines, Samoa, Guam, the U.S. Trust Territories of the Pacific Islands, the Northern Mariana Islands, India, Pakistan, or Bangladesh.

I certify that the business classification and ethnicity indicated above reflects the true and correct status of this business in accordance with current Federal Small Business Administration criteria. I agree to inform Community High School District 99 immediately in writing of any changes to the information contained herein, including changes in ownership, controlling interest or operations. I understand that falsely certifying this information may result in suspension from participation in Community High School District 99 – 2021 Capital Projects North & South

Name: _____ Title: _____
(Print or Type)

Signature: _____ Date: _____

END OF SECTION 004101

BID DATE: February 18th at 10:00 a.m. (CST)
(via Building Connected)

BID TO: Community High School District 99
Administrative Center
6301 Springside Avenue
Downers Grove, IL 60516

RECEIVED BY:

BID FROM: _____

BID FOR: Bid Group 1 - Bid Package #06 - Plumbing
Transition Building
4232 Venard Road
Downers Grove, IL 60516

THE UNDERSIGNED:

Acknowledges receipt of:

Plans and specifications for the work indicated above.

Addenda: No. _____ dated _____
No. _____ dated _____
No. _____ dated _____
No. _____ dated _____

Having examined the site of the work, and having familiarized himself or herself with local conditions affecting the cost of the work and with all requirements of the bidding documents including Instructions to Bidders, drawings, specifications and duly issued addenda as prepared by the architect, Wight & Company, hereby agrees to perform all work and furnish all labor, material and equipment specifically required of him by the bidding documents and such additional work as may be included as related requirements in other divisions or sections of the specifications, exclusive of alternate bids.

Agrees:

To furnish and install the described material and/or services for stated lump sum price.

To hold this bid open until **90** calendar days after bid opening date.

To accept the provisions of the General Provisions (Project Manual Division 0 – Bidding & Contracting Requirements

Section 00201) and disposition of bid security.

To enter into and execute a contract with the Owner, if awarded on the basis of this bid, and in connection therewith to:

1. Furnish all bonds and insurance required by the bidding documents.
2. Accomplish the work in accordance with the contract.
3. Complete the work within the contract time herein specified.

Completion Time:

The undersigned agrees to begin construction immediately, or as directed by the Construction Manager, upon notice of contract award and to perform the following components of the work in accordance with the Construction Manager's Construction. This schedule is bound in the Project Manual. See attached scope of work in section 0300.

SCOPE OF WORK:

The work in this agreement (without additional compensation) shall include, but shall not necessarily be limited to, all skilled labor, supervision, premium time, materials, tools, equipment, plant, supplies, samples, shop drawings, design/engineering drawings, layout, transportation, supervision, contributions, insurance, taxes (if applicable), compliance with all agencies (City / Village, County, State, Federal and/or any other jurisdictional agency, as may be required) and/or all services and facilities necessary and/or required for the performance of all Work shown, detailed, and/or implied by the following documents and as defined herein.

It is understood that this Trade Contractor shall perform the Work for a complete and operational system as indicated or implied in all Contract Documents. It is recognized and understood that the documents upon which the bid is based are at a conceptual phase and this Contractor who has certain skills and judgments based upon his knowledge of techniques, procedures, systems, general state of the art of his specialty is expected to include in the scope of work, all items required in order to carry out a complete and functional system whether or not shown or described in the contract documents. This contract will be awarded on the basis of such documents with the understanding that this contractor is to furnish and install all items required for the proper completion of this work without adjustment to this contract price. No extra payments shall be made of claims entertained as a result of such items, unless it can be clearly demonstrated to be added scope to the contract and beyond the original intent of the documents.

Contractor to provide all Trade Contract work referenced in:

1. Any sheet of this bid group package including (reference Division 0 – Bidding and Contract Requirements, Section 00200 – Notice to Bidders).
2. Specification 00300 Bid Packages Scope Document.

WORK BASE BID: For providing all work including all allowances as required for the completion of the construction of the base bid project as shown on the drawings and specifications and NOT including alternate bids and/or contractor's proposed alternates and substitutes.

BASE BID

TOTAL BASE BID AMOUNT **TRANSITION BUILDING BUILD OUT:**

_____ Dollars (\$ _____)

1. This TRADE CONTRACTOR **shall include an allowance of \$10,000.00 in their base bid** to account for any unforeseen conditions. Contract amounts will be adjusted by change order for amounts greater or less than the allowance. Allowance to be utilized only at the direction of Construction Manager.

BONDS:

This TRADE CONTRACTOR will be required to provide a Performance and Payment Bond for their work in accordance with 00201 of the General Conditions

Award Basis:

The project will be awarded based upon the attached Evaluation Criteria, Section 301a. Owner and Construction Manager alternate's may be considered to find the most qualified bidder if the result of combining the base bid and the selected alternate(s) is the most qualified bid, and is to the benefit of the owner.

Each of the following amounts for alternate construction includes the entire cost of such construction, except as otherwise noted. Acceptance of any or all of the alternates for inclusion in the contract is the sole prerogative of the owner.

All additional costs due to the alternates are included in the amount to be added to the base bid, so that no additional costs will be borne by the owner due to acceptance of alternates. This alternate price is not to be included in the base bid price.

Owner Requested Alternates:

Each of the following amounts for alternate construction includes the entire cost of such construction, except as otherwise noted. Acceptance of any or all of the alternates for inclusion in the contract is the sole prerogative of the owner.

All additional costs due to the alternates are included in the amount to be added to the base bid, so that no additional costs will be borne by the owner due to acceptance of alternates.

Proposed Alternates: (Contractors Proposed Alternates)

Item Specified	Proposed Alternate	Change in Bid Price
1. _____	_____	_____
2. _____	_____	_____
3. _____	_____	_____

Owner Requested Unit Prices/Allowances (as applicable to this Trade Contractor's scope of work) (additive or deductive).

This trade contractor includes _____ dumpsters for all refuse caused by this trade contractor's work in the amount of _____ Dollars (\$_____) Note: trade contractors are to include in their bid form submittal the quantity of dumpsters required to complete their work and the cost associated with same. Dumpster costs will be subtracted by change order. Dumpsters will be procured and managed by Construction Manager. Note: Dumpster use in excess of that proposed by this Trade Contractor will be adjusted by back charge.

Owner Requested Scheduling Information:

Note: The work of this Trade Contractor is to be completed in accordance with the overall project schedule as identified elsewhere in this project manual and/or as subsequently directed by Construction Manager. This Trade Contractor shall submit a proposed submittals list/schedule/material log within five (5) calendar days of Notice To Proceed.

1. Shop drawings / Submittal for this trade contractor will be submitted within 10 calendar days of receipt of notice to proceed.

Bid Acceptance:

If written notice of the acceptance of this bid is mailed, telegraphed or delivered to the undersigned within the time noted herein, after the date of opening of bids or at any time thereafter before this bid is withdrawn, the undersigned agrees that he will execute a construction contract in accordance with the bids as accepted.

The Owner reserves the right to award the contract to its best interests, review and accept any and all value engineering alternatives, negotiate with the lowest responsible bidder, to reject any or all bids, to waive any informalities in bidding and to hold all bids for the bid guarantee period. The Owner reserves the right to award separate contracts for any of the items of work bid herein.

Bid Deposit:

The undersigned furnishes herewith, as required in the Instructions to Bidders, a bid deposit in the amount of ten percent (10%) of the amount bid in the form of Cashier's Check, or Certified Check, made payable to the Owner or Bid Bond, naming the Owner as obligee. (Bidder to check form of deposit furnished.)

It is understood and agreed that should the undersigned fail to enter into a contract with the Owner or furnish acceptable contract security within the time and in the manner herein provided, the bid deposit shall be retained by the Owner as liquidated damages and not as a forfeiture. As it is impossible to determine precisely an exact amount of damages the Owner will sustain, it is agreed that the bid deposit is a fair and equitable estimate of such damages.

REPRESENTATIONS AND CERTIFICATIONS:

The bidder makes the following representations and certifications as part of his bid on the project herein identified in the Bid Form. In the case of a joint venture bid, each party represents and certifies as to his own organization.

AVAILABILITY. The number and amount of contracts and awards pending which I am and/or will be obligated to perform, now and during the course of the project, will not interfere with or hinder the timely prosecution of my work.

SURETY. I have notified a Surety Company that I am submitting a bid for work to be performed on the project. The Surety Company has agreed to issue a performance and labor and material payment bond for my work, if my bid is accepted and the contract awarded to me.

INDEPENDENT PRICE DETERMINATION. The contract sum in this bid has been arrived at independently, without consultation, communication or agreement for the purpose of restricting competition.

PREVAILING WAGE. The contractor and each subcontractor shall pay not less than the general prevailing rate of hourly wages for work of a similar character in the locality in which the work is performed and not less than general prevailing rate of hourly wages for legal holidays and overtime work in the performance of work under this contract, as established by the Illinois Department of Labor, pursuant to an act of the General Assembly of the State of Illinois approved June 26, 1941 as amended according to Section 820 ILCS 130/1.

Pursuant to Section 820 ILCS 130/5, the contractor and each subcontractor shall keep an accurate record showing the names and occupation of all laborers, workers and mechanics employed by them, and also showing the actual hourly wages paid to each such individual, which record shall be open at all reasonable hours to inspection by the Owner, its officers and agents, and to agents of the Illinois Department of Labor.

The contractor and each subcontractor hereby agree, jointly and severally, to defend, indemnify and hold harmless the Owner from any and all claims, demands, liens or suits of any kind or nature whatsoever (including suits for injunctive relief) by the Illinois Department of Labor under the Illinois Prevailing Wage Act, Section 820 ILCS 130/1., or by any laborer, worker or mechanic employed by the contractor or the subcontractor who alleges that he has been paid for his services in a sum less than prevailing wage rates required by Illinois law. The Owner agrees to notify the contractor or subcontractor of the pendency of any such claim, demand, lien or suit.

By submitting a bid, each bidder agrees to waive any claim it has or may have against the Owner, the Architect, Engineer, Construction Manager and their respective employees, arising out of or in connection with the administration, evaluation, or recommendation of any bid; waiver of any requirements under the Bid Documents; or the Contract Document; acceptance or rejection of any bids; and award of the Contract.

Signature:

Respectfully submitted this _____ day _____, 2021

Type of Firm (Bidder to indicate)

_____ Individual

_____ Partnership

_____ Corporation

_____ Joint Venture

_____ Other

(CORPORATE SEAL)

(Firm Name)

(Address)

(Telephone Number)

(FAX)

(E-mail Address)

(Bidder's Signature)

(Title)

Subscribed and sworn to me
this . day of __, 2020

NOTE: All pages of this bid form must be returned with your proposal. Failure to do so shall disqualify your bid.

CERTIFICATE OF BIDDER ELIGIBILITY

720 ILCS 5/33E-11 REQUIRES THAT ALL CONTRACTORS BIDDING FOR PUBLIC AGENCIES IN THE State of Illinois certify that they are not barred from bidding on public contracts for bid rigging or bid rotation.

The following certification must be signed and submitted with bidder's bid proposal. FAILURE TO DO SO MAY RESULT IN DISQUALIFICATION OF THE BIDDER.

_____, as part of its bid for the _____ work for Community High School District 99, Downers Grove, Illinois, DuPage County, Illinois certified that said contractor is not barred from bidding on the aforementioned contract as a result of violation of either 720 ILCS 5/33E-3 or 720 ILCS 5/33-E4.

Firm: _____

By: _____
(Signature)

(Printed Name & Title)

SUBSCRIBED AND SWORN TO before me

This _____ day of _____, 202

NOTARY PUBLIC

**CRIMINAL CODE CERTIFICATION
AS REQUIRED BY:
STATE OF ILLINOIS CRIMINAL CODE OF 2012, 720 ILCS 5/33E-11**

I, _____ the individual whose signature appears below on this bid/contract
for _____ hereby certify that the bidding party/contracting party
is not barred from bidding on the contract as a result of a violation of either Section 33E-3 or Section 33E-4 of 720 ILCS 5/33E-
3 or 5/33E-4 of the Illinois Compiled Statutes, as amended.

By: _____
Authorized Agent of Contractor (name and title)

SUBSCRIBED AND SWORN to before
me this ____ day _____, 20__.

Notary Public

EQUAL EMPLOYMENT OPPORTUNITY

Section I. This EQUAL EMPLOYMENT OPPORTUNITY CLAUSE is required by the Illinois Human Rights Act and the Rules and Regulations of the Illinois Department of Human Rights published at 44 Illinois Administrative Code Section 750, *et seq.*

Section II. In the event of the Contractor's noncompliance with any provision of this Equal Employment Opportunity Clause, the Illinois Human Rights Act, or the Rules and Regulations of the Department of Human Rights (hereinafter referred to as the Department) the Contractor may be declared ineligible for future contracts or subcontracts with the State of Illinois or any of its political subdivisions or municipal corporations, and this Contract may be canceled or voided in whole or in part, and other sanctions or penalties may be imposed or remedies involved as provided by statute or regulation.

During the performance of this Agreement, the Contractor agrees:

A. That it will not discriminate against any employee or applicant for employment because of race, color, religion, sex, sexual orientation, national origin or ancestry, citizenship status, age, physical or mental disability unrelated to ability, military status or an unfavorable discharge from military service; and further that it will examine all job classifications to determine if minority persons or women are underutilized and will take appropriate affirmative action to rectify any such underutilization.

B. That, if it hires additional employees in order to perform this Contract, or any portion hereof, it will determine the availability (in accordance with the Department's Rules and Regulations) of minorities and women in the area(s) from which it may reasonably recruit and it will hire for each job classification for which employees are hired in such a way that minorities and women are not underutilized.

C. That, in all solicitations or advertisements for employees placed by it or on its behalf, it will state that all applicants will be afforded equal opportunity without discrimination because of race, color, religion, sex, sexual orientation, marital status, national origin or ancestry, citizenship status, age, or physical or mental handicap unrelated to ability, military status or an unfavorable discharge from military service.

D. That it will send to each labor organization or representative of workers with which it has or is bound by a collective bargaining or other agreement or understanding, a notice advising such labor organization or representative of the Vendor's obligations under the Illinois Human Rights Act and Department's Rules and Regulations. If any labor organization or representative fails or refuses to cooperate with the Contractor in its efforts to comply with the Act and Rules and Regulations, the Contractor will promptly notify the Department and the contracting agency and will recruit employees from other sources when necessary to fulfill its obligations under the Contract.

E. That it will submit reports as required by the Department's Rules and Regulations, furnish all relevant information as may from time to time be requested by the Department or the contracting agency, and in all respects comply with the Illinois Human Rights Act and Department's Rules and Regulations.

F. That it will permit access to all relevant books, records, accounts and work sites by personnel of the contracting agency and Department for purposes of investigation to ascertain compliance with the Illinois Human Rights Act and Department's Rules and Regulations.

G. That it will include verbatim or by reference the provisions of this Equal Employment Opportunity Clause in every subcontract it awards under which any portion of this Contract obligations are undertaken or assumed, so that such provisions will be binding upon such subcontractor. In the same manner as the other provisions of this Agreement, the Contractor will be liable for compliance with applicable provisions of this clause by such subcontractors; and further it will promptly notify the contracting agency and the Department in the event any subcontractor fails or refuses to comply therewith. In addition, the Contractor will not utilize any subcontractor declared by the Illinois Human Rights Department to be ineligible for contracts or subcontracts with the State of Illinois or any of its political subdivisions or municipal corporations.

ACKNOWLEDGED AND AGREED TO:

By: _____
Authorized Agent of Contractor (name and title)

DATE: _____

SEXUAL HARASSMENT POLICY

_____, having submitted a bid for _____ (Name of Contractor)
_____ to Community High School District No. 00, hereby certifies that
said contractor has a written sexual harassment policy in place in full compliance with 775 ILCS 5/2-105 (A) (4).

By: _____
Authorized Agent of Contractor (name and title)

SUBSCRIBED AND SWORN to before
me this ____ day _____, 20__.

Notary Public

TAX CERTIFICATION

I, _____, having been first duly sworn depose and state as follows:

I, _____, am the duly authorized agent for
High School District No. 99 for

_____ and I hereby certify that _____ is not delinquent in the payment of any tax administered by the Illinois Department of Revenue, or if it is:

a. it is contesting its liability for the tax or the amount of tax in accordance with procedures established by the appropriate Revenue Act; or

b. it has entered into an agreement with the Department of Revenue for payment of all taxes due and is currently in compliance with that agreement.

By: _____
Authorized Agent of Contractor (name and title)

SUBSCRIBED AND SWORN to before
me this ____ day _____, 20__.

Notary Public

SUBSTANCE ABUSE PREVENTION ON PUBLIC WORKS PROJECTS

The Contractor certifies that it has in place a written program that meets or exceeds the program requirements of the Substance Abuse Prevention on Public Works Projects Act (Public Act 95-0635), and will provide a copy thereof to Community High School District No. 99 prior to commencement of work on the Project.

By: _____
Authorized Agent of Contractor (name and title)

SUBSCRIBED AND SWORN to before
me this ____ day _____, 20__.

Notary Public

**CERTIFICATE REGARDING
EMPLOYMENT OF ILLINOIS WORKERS ON PUBLIC WORKS**

_____ agrees if at the time the Agreement is executed, or if during the term of the Agreement, there is excessive unemployment in Illinois as defined in the Employment of Illinois Workers on Public Works Act, 30- ILCS 570/0/01 et seq., as two consecutive months of unemployment exceeding 5%, then _____ agrees to employ Illinois laborers in accordance with the Employment of Illinois Workers on Public Works Act. An "Illinois laborer" is defined as any person who has resided in Illinois for at least thirty (30) days and intends to become or remain an Illinois resident.

Firm: _____

By: _____
(Signature)

(Printed Name & Title)

SUBSCRIBED AND SWORN TO before me

This _____ day of _____, 2021

NOTARY PUBLIC

PREVAILING WAGE AFFIDAVIT

AFFIDAVIT: "I (we) hereby certify and affirm that if awarded a contract with Community High School District 99, we will comply fully with the "Illinois Prevailing Wage Act (Ill. Rev. Stat., 1987 Ch. 48, Sections 398 s-1-12 as amended by Public Act 86-693 and 86-799 effected January 1, 1990, and any other amendments effective thereafter)". We further understand that current prevailing wage standards are included in the Supplementary General Conditions.

The following affidavit must be signed and submitted with bidder's bid proposal. FAILURE TO DO SO MAY RESULT IN DISQUALIFICATION OF THE BIDDER.

_____, as part of its bid for the _____ work for Community High School District 99, Downers Grove, Illinois, certifies that said contractor is not barred from bidding on the aforementioned contract as a result of a violation of the Illinois Prevailing Wage Act (Ill. Rev. Stat., 1987 Ch. 48, Sections 398 s-1-12 as amended by Public Act 86-693 and 86-799 effected January 1, 1990).

Firm: _____

By: _____
(Signature)

(Printed Name & Title)

SUBSCRIBED AND SWORN TO before me

This _____ day of _____, 2021

NOTARY PUBLIC

NON-COLLUSION AFFIDAVIT

AFFIDAVIT: "I (we) hereby certify and affirm that my (our) proposal was prepared independently for this project and that it contains no fees or amounts other than that for the legitimate execution of this work as specified and that it includes no understanding or agreements in restraint of trade."

The following affidavit must be signed and submitted with bidder's bid proposal.
FAILURE TO DO SO MAY RESULT IN DISQUALIFICATION OF THE BIDDER.

_____, as a part of its bid for the _____ work for Community High School District 99, Downers Grove, Illinois, certifies that said Contractor is not barred from bidding on the aforementioned contract as a result of a violation of the above Non-Collusion Affidavit.

Firm: _____

By: _____
(Signature)

(Printed Name & Title)

SUBSCRIBED AND SWORN TO before me

This _____ day of _____, 2021

NOTARY PUBLIC

Criminal Background Investigations

Contractor hereby represents, warrants and certified that no officer or director thereof has any knowledge that any employee thereof has been convicted of committing or attempting to commit "Criminal Code of 1961," 720 ILCS, Sections 5/11-6 (Indecent solicitation of a child), 5/11-9 (Public indecency), 5/11-14 (Prostitution), 5/11-15 (Soliciting for a prostitute), 5/11-15.1 (Soliciting for a juvenile prostitute), 5/11-19 (Pimping), 5/11-19.1 (Juvenile pimping), 5/11-19.2 (Exploitation of a child), 5/11-20 (Obscenity), 5/11-20.1 (Sexual assault), 5/12-14 (Aggravated criminal sexual assault), 5/12-15 (Criminal sexual abuse), and 5/120-16 (Aggravated criminal sexual abuse), and/or those offenses defined in the "Cannabis Control Act," 720 ILCS, 550/1 et seq. (except the "Illinois Controlled Substances Act," 720 ILCS 570/100 et seq. and/or any offense committed or attempted in any other state or against the laws of the United States, which if committed or attempted in this State, would have been punishable as one or more of the foregoing offenses.

Contractor further agrees that it shall not employ any person who have or may have direct, daily contact with the pupils of any school in the district, and for whom a criminal background investigation has not been conducted pursuant hereto, and further represents and agrees that all applicants for any such employment shall furnish with their applications the attached written "Authorization for Criminal Background Information" form authorizing the Board of Education to request a criminal background investigation of said applicant pursuant to Section 5/10-21.9 of the School Code of Illinois and to receive criminal history record information pursuant thereto to determine if the applicant has been convicted of committing or attempting to commit any of the criminal or drug offenses enumerated above. Contractor further agrees to submit with said authorization payment for any costs and expenses associated with the criminal background investigation.

Contractor further represents, warrants, and certifies that no applicant for employment with respect to whom the criminal investigation reveals any conviction for committing and/or attempting to commit any of the above enumerated offenses shall be employed thereby in any position that involves or may involve contact with the students of the school district.

This certification is executed on the date hereinafter indicated by the designated contractor by its duly authorized officer.

Firm: _____

By: _____
(Signature)

(Printed Name & Title)

Date: _____

Criminal Background Investigation

The undersigned hereby authorizes in Board of Education of Community High School District 99, Downers Grove, Illinois, to request a criminal background investigation from the Illinois State Police, pursuant to Section 5/10-21.9 of the School Code of Illinois, 105 ILCS 5/10-21.9 and to receive criminal history record information pursuant thereto.

By: _____
(Signature of Applicant of Employee)

(Printed or Typed Name of Applicant Employee)

Date: _____

BUSINESS CLASSIFICATION

a) Business Entity (check one)

Corporation (Publicly held)* Not-for-Profit* Government Agency/Public Institution*
 Corporation (Privately held) Partnership Sole Proprietor

* If checked, do not complete section III (b) and (c) below.

b) Business Ownership (check one) If minority or woman owned, attach copy of certification evidence.

Large Business: Male Owned Woman Owned
Small Business: Male Owned Woman Owned

BUSINESS DEFINITIONS

Small Business Concern - an independently owned and operated concern certified, or certifiable, as a small business by the Federal Small Business Administration (SBA). Standard Industrial Classification (SIC) codes may be found in the Federal Acquisition Regulations, Section 19.102 or in the Federal Procurement Regulations, Section 1-1.701.

Small Disadvantaged or Minority Business Concern - a small business concern which is at least fifty-one percent (51%) owned by one or more socially and economically disadvantaged individuals or in the case of any publicly owned business, at least fifty-one percent (51%) of the stock of which is owned by such individuals; and whose management and daily business operations are controlled by one or more of such individuals. Business owners who certify that they are members of named groups (Black Americans, Hispanic Americans, Native Americans, Asian-Pacific Americans) are considered socially and economically disadvantaged.

Woman-Owned Business - a business concern that is at least fifty-one percent (51%) owned by a woman or women who also control and operate it. "Control" in this context means exercising the power to make policy decisions. "Operate" in this context means being actively involved in the day-to-day management.

c) Race/Ethnicity of Ownership (check one) based on definitions below.

Black Asian/Pacific or Asian/Indian Caucasian
 Hispanic Native American (American Indians, Eskimos, Aleuts and native Hawaiians)

ETHNIC GROUP DEFINITIONS

Black Americans: United States citizens whose origins are in any of the Black racial groups of Africa.
Hispanic Americans: United States citizens whose origins are in Mexico, Puerto Rico, Cuba, Portugal, Central or Central America.
Native Americans: United States citizens whose origins are in any of the original peoples of North America, i.e., American Indians, Eskimos, Aleuts and native Hawaiians.
Asian Pacific/Asian Indian Americans: United States citizens whose origins are in Japan, China, Korea, Taiwan, Cambodia, Laos, Vietnam, the Philippines, Samoa, Guam, the U.S. Trust Territories of the Pacific Islands, the Northern Mariana Islands, India, Pakistan, or Bangladesh.

I certify that the business classification and ethnicity indicated above reflects the true and correct status of this business in accordance with current Federal Small Business Administration criteria. I agree to inform Community High School District 99 immediately in writing of any changes to the information contained herein, including changes in ownership, controlling interest or operations. I understand that falsely certifying this information may result in suspension from participation in Community High School District 99 – 2021 Capital Projects North & South

Name: _____ Title: _____
(Print or Type)

Signature: _____ Date: _____

END OF SECTION 004101

BID DATE: February 18th at 10:00 a.m. (CST)
(via Building Connected)

BID TO: Community High School District 99
Administrative Center
6301 Springside Avenue
Downers Grove, IL 60516

RECEIVED BY:

BID FROM: _____

BID FOR: Bid Group 1 - Bid Package #07 – Fire Suppression
Transition Building
4232 Venard Road
Downers Grove, IL 60516

THE UNDERSIGNED:

Acknowledges receipt of:

Plans and specifications for the work indicated above.

Addenda: No. _____ dated _____
No. _____ dated _____
No. _____ dated _____
No. _____ dated _____

Having examined the site of the work, and having familiarized himself or herself with local conditions affecting the cost of the work and with all requirements of the bidding documents including Instructions to Bidders, drawings, specifications and duly issued addenda as prepared by the architect, Wight & Company, hereby agrees to perform all work and furnish all labor, material and equipment specifically required of him by the bidding documents and such additional work as may be included as related requirements in other divisions or sections of the specifications, exclusive of alternate bids.

Agrees:

To furnish and install the described material and/or services for stated lump sum price.

To hold this bid open until **90** calendar days after bid opening date.

To accept the provisions of the General Provisions (Project Manual Division 0 – Bidding & Contracting Requirements

Section 00201) and disposition of bid security.

To enter into and execute a contract with the Owner, if awarded on the basis of this bid, and in connection therewith to:

1. Furnish all bonds and insurance required by the bidding documents.
2. Accomplish the work in accordance with the contract.
3. Complete the work within the contract time herein specified.

Completion Time:

The undersigned agrees to begin construction immediately, or as directed by the Construction Manager, upon notice of contract award and to perform the following components of the work in accordance with the Construction Manager's Construction. This schedule is bound in the Project Manual. See attached scope of work in section 0300.

SCOPE OF WORK:

The work in this agreement (without additional compensation) shall include, but shall not necessarily be limited to, all skilled labor, supervision, premium time, materials, tools, equipment, plant, supplies, samples, shop drawings, design/engineering drawings, layout, transportation, supervision, contributions, insurance, taxes (if applicable), compliance with all agencies (City / Village, County, State, Federal and/or any other jurisdictional agency, as may be required) and/or all services and facilities necessary and/or required for the performance of all Work shown, detailed, and/or implied by the following documents and as defined herein.

It is understood that this Trade Contractor shall perform the Work for a complete and operational system as indicated or implied in all Contract Documents. It is recognized and understood that the documents upon which the bid is based are at a conceptual phase and this Contractor who has certain skills and judgments based upon his knowledge of techniques, procedures, systems, general state of the art of his specialty is expected to include in the scope of work, all items required in order to carry out a complete and functional system whether or not shown or described in the contract documents. This contract will be awarded on the basis of such documents with the understanding that this contractor is to furnish and install all items required for the proper completion of this work without adjustment to this contract price. No extra payments shall be made of claims entertained as a result of such items, unless it can be clearly demonstrated to be added scope to the contract and beyond the original intent of the documents.

Contractor to provide all Trade Contract work referenced in:

1. Any sheet of this bid group package including (reference Division 0 – Bidding and Contract Requirements, Section 00200 – Notice to Bidders).
2. Specification 00300 Bid Packages Scope Document.

WORK BASE BID: For providing all work including all allowances as required for the completion of the construction of the base bid project as shown on the drawings and specifications and NOT including alternate bids and/or contractor's proposed alternates and substitutes.

BASE BID

TOTAL BASE BID AMOUNT **TRANSITION BUILDING BUILD OUT:**

_____ Dollars (\$ _____)

1. This TRADE CONTRACTOR **shall include an allowance of \$5,000.00 in their base bid** to account for any unforeseen conditions. Contract amounts will be adjusted by change order for amounts greater or less than the allowance. Allowance to be utilized only at the direction of Construction Manager.

BONDS:

This TRADE CONTRACTOR will be required to provide a Performance and Payment Bond for their work in accordance with 00201 of the General Conditions

Award Basis:

The project will be awarded based upon the attached Evaluation Criteria, Section 301a. Owner and Construction Manager alternate's may be considered to find the most qualified bidder if the result of combining the base bid and the selected alternate(s) is the most qualified bid, and is to the benefit of the owner.

Each of the following amounts for alternate construction includes the entire cost of such construction, except as otherwise noted. Acceptance of any or all of the alternates for inclusion in the contract is the sole prerogative of the owner.

All additional costs due to the alternates are included in the amount to be added to the base bid, so that no additional costs will be borne by the owner due to acceptance of alternates. This alternate price is not to be included in the base bid price.

Owner Requested Alternates:

Each of the following amounts for alternate construction includes the entire cost of such construction, except as otherwise noted. Acceptance of any or all of the alternates for inclusion in the contract is the sole prerogative of the owner.

All additional costs due to the alternates are included in the amount to be added to the base bid, so that no additional costs will be borne by the owner due to acceptance of alternates.

Proposed Alternates: (Contractors Proposed Alternates)

Item Specified	Proposed Alternate	Change in Bid Price
1. _____	_____	_____
2. _____	_____	_____
3. _____	_____	_____

Owner Requested Unit Prices/Allowances (as applicable to this Trade Contractor's scope of work) (additive or deductive).

This trade contractor includes _____ dumpsters for all refuse caused by this trade contractor's work in the amount of _____ Dollars (\$_____) Note: trade contractors are to include in their bid form submittal the quantity of dumpsters required to complete their work and the cost associated with same. Dumpster costs will be subtracted by change order. Dumpsters will be procured and managed by Construction Manager. Note: Dumpster use in excess of that proposed by this Trade Contractor will be adjusted by back charge.

Owner Requested Scheduling Information:

Note: The work of this Trade Contractor is to be completed in accordance with the overall project schedule as identified elsewhere in this project manual and/or as subsequently directed by Construction Manager. This Trade Contractor shall submit a proposed submittals list/schedule/material log within five (5) calendar days of Notice To Proceed.

1. Shop drawings / Submittal for this trade contractor will be submitted within 10 calendar days of receipt of notice to proceed.

Bid Acceptance:

If written notice of the acceptance of this bid is mailed, telegraphed or delivered to the undersigned within the time noted herein, after the date of opening of bids or at any time thereafter before this bid is withdrawn, the undersigned agrees that he will execute a construction contract in accordance with the bids as accepted.

The Owner reserves the right to award the contract to its best interests, review and accept any and all value engineering alternatives, negotiate with the lowest responsible bidder, to reject any or all bids, to waive any informalities in bidding and to hold all bids for the bid guarantee period. The Owner reserves the right to award separate contracts for any of the items of work bid herein.

Bid Deposit:

The undersigned furnishes herewith, as required in the Instructions to Bidders, a bid deposit in the amount of ten percent (10%) of the amount bid in the form of Cashier's Check, or Certified Check, made payable to the Owner or Bid Bond, naming the Owner as obligee. (Bidder to check form of deposit furnished.)

It is understood and agreed that should the undersigned fail to enter into a contract with the Owner or furnish acceptable contract security within the time and in the manner herein provided, the bid deposit shall be retained by the Owner as liquidated damages and not as a forfeiture. As it is impossible to determine precisely an exact amount of damages the Owner will sustain, it is agreed that the bid deposit is a fair and equitable estimate of such damages.

REPRESENTATIONS AND CERTIFICATIONS:

The bidder makes the following representations and certifications as part of his bid on the project herein identified in the Bid Form. In the case of a joint venture bid, each party represents and certifies as to his own organization.

AVAILABILITY. The number and amount of contracts and awards pending which I am and/or will be obligated to perform, now and during the course of the project, will not interfere with or hinder the timely prosecution of my work.

SURETY. I have notified a Surety Company that I am submitting a bid for work to be performed on the project. The Surety Company has agreed to issue a performance and labor and material payment bond for my work, if my bid is accepted and the contract awarded to me.

INDEPENDENT PRICE DETERMINATION. The contract sum in this bid has been arrived at independently, without consultation, communication or agreement for the purpose of restricting competition.

PREVAILING WAGE. The contractor and each subcontractor shall pay not less than the general prevailing rate of hourly wages for work of a similar character in the locality in which the work is performed and not less than general prevailing rate of hourly wages for legal holidays and overtime work in the performance of work under this contract, as established by the Illinois Department of Labor, pursuant to an act of the General Assembly of the State of Illinois approved June 26, 1941 as amended according to Section 820 ILCS 130/1.

Pursuant to Section 820 ILCS 130/5, the contractor and each subcontractor shall keep an accurate record showing the names and occupation of all laborers, workers and mechanics employed by them, and also showing the actual hourly wages paid to each such individual, which record shall be open at all reasonable hours to inspection by the Owner, its officers and agents, and to agents of the Illinois Department of Labor.

The contractor and each subcontractor hereby agree, jointly and severally, to defend, indemnify and hold harmless the Owner from any and all claims, demands, liens or suits of any kind or nature whatsoever (including suits for injunctive relief) by the Illinois Department of Labor under the Illinois Prevailing Wage Act, Section 820 ILCS 130/1., or by any laborer, worker or mechanic employed by the contractor or the subcontractor who alleges that he has been paid for his services in a sum less than prevailing wage rates required by Illinois law. The Owner agrees to notify the contractor or subcontractor of the pendency of any such claim, demand, lien or suit.

By submitting a bid, each bidder agrees to waive any claim it has or may have against the Owner, the Architect, Engineer, Construction Manager and their respective employees, arising out of or in connection with the administration, evaluation, or recommendation of any bid; waiver of any requirements under the Bid Documents; or the Contract Document; acceptance or rejection of any bids; and award of the Contract.

Signature:

Respectfully submitted this _____ day _____, 2021

Type of Firm (Bidder to indicate)

_____ Individual

_____ Partnership

_____ Corporation

_____ Joint Venture

_____ Other

(CORPORATE SEAL)

(Firm Name)

(Address)

(Telephone Number)

(FAX)

(E-mail Address)

(Bidder's Signature)

(Title)

Subscribed and sworn to me
this . day of __, 2020

NOTE: All pages of this bid form must be returned with your proposal. Failure to do so shall disqualify your bid.

CERTIFICATE OF BIDDER ELIGIBILITY

720 ILCS 5/33E-11 REQUIRES THAT ALL CONTRACTORS BIDDING FOR PUBLIC AGENCIES IN THE State of Illinois certify that they are not barred from bidding on public contracts for bid rigging or bid rotation.

The following certification must be signed and submitted with bidder's bid proposal. FAILURE TO DO SO MAY RESULT IN DISQUALIFICATION OF THE BIDDER.

_____, as part of its bid for the _____ work for Community High School District 99, Downers Grove, Illinois, DuPage County, Illinois certified that said contractor is not barred from bidding on the aforementioned contract as a result of violation of either 720 ILCS 5/33E-3 or 720 ILCS 5/33-E4.

Firm: _____

By: _____
(Signature)

(Printed Name & Title)

SUBSCRIBED AND SWORN TO before me

This _____ day of _____, 202

NOTARY PUBLIC

**CRIMINAL CODE CERTIFICATION
AS REQUIRED BY:
STATE OF ILLINOIS CRIMINAL CODE OF 2012, 720 ILCS 5/33E-11**

,
I, _____ the individual whose signature appears below on this bid/contract
for _____ hereby certify that the bidding party/contracting party
is not barred from bidding on the contract as a result of a violation of either Section 33E-3 or Section 33E-4 of 720 ILCS 5/33E-
3 or 5/33E-4 of the Illinois Compiled Statutes, as amended.

By: _____
Authorized Agent of Contractor (name and title)

SUBSCRIBED AND SWORN to before
me this ____ day _____, 20__.

Notary Public

EQUAL EMPLOYMENT OPPORTUNITY

Section I. This EQUAL EMPLOYMENT OPPORTUNITY CLAUSE is required by the Illinois Human Rights Act and the Rules and Regulations of the Illinois Department of Human Rights published at 44 Illinois Administrative Code Section 750, *et seq.*

Section II. In the event of the Contractor's noncompliance with any provision of this Equal Employment Opportunity Clause, the Illinois Human Rights Act, or the Rules and Regulations of the Department of Human Rights (hereinafter referred to as the Department) the Contractor may be declared ineligible for future contracts or subcontracts with the State of Illinois or any of its political subdivisions or municipal corporations, and this Contract may be canceled or voided in whole or in part, and other sanctions or penalties may be imposed or remedies involved as provided by statute or regulation.

During the performance of this Agreement, the Contractor agrees:

A. That it will not discriminate against any employee or applicant for employment because of race, color, religion, sex, sexual orientation, national origin or ancestry, citizenship status, age, physical or mental disability unrelated to ability, military status or an unfavorable discharge from military service; and further that it will examine all job classifications to determine if minority persons or women are underutilized and will take appropriate affirmative action to rectify any such underutilization.

B. That, if it hires additional employees in order to perform this Contract, or any portion hereof, it will determine the availability (in accordance with the Department's Rules and Regulations) of minorities and women in the area(s) from which it may reasonably recruit and it will hire for each job classification for which employees are hired in such a way that minorities and women are not underutilized.

C. That, in all solicitations or advertisements for employees placed by it or on its behalf, it will state that all applicants will be afforded equal opportunity without discrimination because of race, color, religion, sex, sexual orientation, marital status, national origin or ancestry, citizenship status, age, or physical or mental handicap unrelated to ability, military status or an unfavorable discharge from military service.

D. That it will send to each labor organization or representative of workers with which it has or is bound by a collective bargaining or other agreement or understanding, a notice advising such labor organization or representative of the Vendor's obligations under the Illinois Human Rights Act and Department's Rules and Regulations. If any labor organization or representative fails or refuses to cooperate with the Contractor in its efforts to comply with the Act and Rules and Regulations, the Contractor will promptly notify the Department and the contracting agency and will recruit employees from other sources when necessary to fulfill its obligations under the Contract.

E. That it will submit reports as required by the Department's Rules and Regulations, furnish all relevant information as may from time to time be requested by the Department or the contracting agency, and in all respects comply with the Illinois Human Rights Act and Department's Rules and Regulations.

F. That it will permit access to all relevant books, records, accounts and work sites by personnel of the contracting agency and Department for purposes of investigation to ascertain compliance with the Illinois Human Rights Act and Department's Rules and Regulations.

G. That it will include verbatim or by reference the provisions of this Equal Employment Opportunity Clause in every subcontract it awards under which any portion of this Contract obligations are undertaken or assumed, so that such provisions will be binding upon such subcontractor. In the same manner as the other provisions of this Agreement, the Contractor will be liable for compliance with applicable provisions of this clause by such subcontractors; and further it will promptly notify the contracting agency and the Department in the event any subcontractor fails or refuses to comply therewith. In addition, the Contractor will not utilize any subcontractor declared by the Illinois Human Rights Department to be ineligible for contracts or subcontracts with the State of Illinois or any of its political subdivisions or municipal corporations.

ACKNOWLEDGED AND AGREED TO:

By: _____
Authorized Agent of Contractor (name and title)

DATE: _____

SEXUAL HARASSMENT POLICY

_____, having submitted a bid for _____ (Name of Contractor)
_____ to Community High School District No. 00, hereby certifies that
said contractor has a written sexual harassment policy in place in full compliance with 775 ILCS 5/2-105 (A) (4).

By: _____
Authorized Agent of Contractor (name and title)

SUBSCRIBED AND SWORN to before
me this ____ day _____, 20__.

Notary Public

TAX CERTIFICATION

I, _____, having been first duly sworn depose and state as follows:

I, _____, am the duly authorized agent for
High School District No. 99 for

_____ and I hereby certify that _____ is not delinquent in the payment of any tax administered by the Illinois Department of Revenue, or if it is:

a. it is contesting its liability for the tax or the amount of tax in accordance with procedures established by the appropriate Revenue Act; or

b. it has entered into an agreement with the Department of Revenue for payment of all taxes due and is currently in compliance with that agreement.

By: _____
Authorized Agent of Contractor (name and title)

SUBSCRIBED AND SWORN to before
me this ____ day _____, 20__.

Notary Public

SUBSTANCE ABUSE PREVENTION ON PUBLIC WORKS PROJECTS

The Contractor certifies that it has in place a written program that meets or exceeds the program requirements of the Substance Abuse Prevention on Public Works Projects Act (Public Act 95-0635), and will provide a copy thereof to Community High School District No. 99 prior to commencement of work on the Project.

By: _____
Authorized Agent of Contractor (name and title)

SUBSCRIBED AND SWORN to before
me this ____ day _____, 20__.

Notary Public

**CERTIFICATE REGARDING
EMPLOYMENT OF ILLINOIS WORKERS ON PUBLIC WORKS**

_____ agrees if at the time the Agreement is executed, or if during the term of the Agreement, there is excessive unemployment in Illinois as defined in the Employment of Illinois Workers on Public Works Act, 30- ILCS 570/0/01 et seq., as two consecutive months of unemployment exceeding 5%, then _____ agrees to employ Illinois laborers in accordance with the Employment of Illinois Workers on Public Works Act. An "Illinois laborer" is defined as any person who has resided in Illinois for at least thirty (30) days and intends to become or remain an Illinois resident.

Firm: _____

By: _____
(Signature)

(Printed Name & Title)

SUBSCRIBED AND SWORN TO before me

This _____ day of _____, 2021

NOTARY PUBLIC

PREVAILING WAGE AFFIDAVIT

AFFIDAVIT: "I (we) hereby certify and affirm that if awarded a contract with Community High School District 99, we will comply fully with the "Illinois Prevailing Wage Act (Ill. Rev. Stat., 1987 Ch. 48, Sections 398 s-1-12 as amended by Public Act 86-693 and 86-799 effected January 1, 1990, and any other amendments effective thereafter)". We further understand that current prevailing wage standards are included in the Supplementary General Conditions.

The following affidavit must be signed and submitted with bidder's bid proposal. FAILURE TO DO SO MAY RESULT IN DISQUALIFICATION OF THE BIDDER.

_____, as part of its bid for the _____ work for Community High School District 99, Downers Grove, Illinois, certifies that said contractor is not barred from bidding on the aforementioned contract as a result of a violation of the Illinois Prevailing Wage Act (Ill. Rev. Stat., 1987 Ch. 48, Sections 398 s-1-12 as amended by Public Act 86-693 and 86-799 effected January 1, 1990).

Firm: _____

By: _____

(Signature)

(Printed Name & Title)

SUBSCRIBED AND SWORN TO before me

This _____ day of _____, 2021

NOTARY PUBLIC

NON-COLLUSION AFFIDAVIT

AFFIDAVIT: "I (we) hereby certify and affirm that my (our) proposal was prepared independently for this project and that it contains no fees or amounts other than that for the legitimate execution of this work as specified and that it includes no understanding or agreements in restraint of trade."

The following affidavit must be signed and submitted with bidder's bid proposal.
FAILURE TO DO SO MAY RESULT IN DISQUALIFICATION OF THE BIDDER.

_____, as a part of its bid for the _____ work for Community High School District 99, Downers Grove, Illinois, certifies that said Contractor is not barred from bidding on the aforementioned contract as a result of a violation of the above Non-Collusion Affidavit.

Firm: _____

By: _____
(Signature)

(Printed Name & Title)

SUBSCRIBED AND SWORN TO before me

This _____ day of _____, 2021

NOTARY PUBLIC

Criminal Background Investigations

Contractor hereby represents, warrants and certified that no officer or director thereof has any knowledge that any employee thereof has been convicted of committing or attempting to commit "Criminal Code of 1961," 720 ILCS, Sections 5/11-6 (Indecent solicitation of a child), 5/11-9 (Public indecency), 5/11-14 (Prostitution), 5/11-15 (Soliciting for a prostitute), 5/11-15.1 (Soliciting for a juvenile prostitute), 5/11-19 (Pimping), 5/11-19.1 (Juvenile pimping), 5/11-19.2 (Exploitation of a child), 5/11-20 (Obscenity), 5/11-20.1 (Sexual assault), 5/12-14 (Aggravated criminal sexual assault), 5/12-15 (Criminal sexual abuse), and 5/120-16 (Aggravated criminal sexual abuse), and/or those offenses defined in the "Cannabis Control Act," 720 ILCS, 550/1 et seq. (except the "Illinois Controlled Substances Act," 720 ILCS 570/100 et seq. and/or any offense committed or attempted in any other state or against the laws of the United States, which if committed or attempted in this State, would have been punishable as one or more of the foregoing offenses.

Contractor further agrees that it shall not employ any person who have or may have direct, daily contact with the pupils of any school in the district, and for whom a criminal background investigation has not been conducted pursuant hereto, and further represents and agrees that all applicants for any such employment shall furnish with their applications the attached written "Authorization for Criminal Background Information" form authorizing the Board of Education to request a criminal background investigation of said applicant pursuant to Section 5/10-21.9 of the School Code of Illinois and to receive criminal history record information pursuant thereto to determine if the applicant has been convicted of committing or attempting to commit any of the criminal or drug offenses enumerated above. Contractor further agrees to submit with said authorization payment for any costs and expenses associated with the criminal background investigation.

Contractor further represents, warrants, and certifies that no applicant for employment with respect to whom the criminal investigation reveals any conviction for committing and/or attempting to commit any of the above enumerated offenses shall be employed thereby in any position that involves or may involve contact with the students of the school district.

This certification is executed on the date hereinafter indicated by the designated contractor by its duly authorized officer.

Firm: _____

By: _____
(Signature)

(Printed Name & Title)

Date: _____

Criminal Background Investigation

The undersigned hereby authorizes in Board of Education of Community High School District 99, Downers Grove, Illinois, to request a criminal background investigation from the Illinois State Police, pursuant to Section 5/10-21.9 of the School Code of Illinois, 105 ILCS 5/10-21.9 and to receive criminal history record information pursuant thereto.

By: _____
(Signature of Applicant of Employee)

(Printed or Typed Name of Applicant Employee)

Date: _____

BUSINESS CLASSIFICATION

a) Business Entity (check one)

Corporation (Publicly held)* Not-for-Profit* Government Agency/Public Institution*
 Corporation (Privately held) Partnership Sole Proprietor

* If checked, do not complete section III (b) and (c) below.

b) Business Ownership (check one) If minority or woman owned, attach copy of certification evidence.

Large Business: Male Owned Woman Owned
Small Business: Male Owned Woman Owned

BUSINESS DEFINITIONS

Small Business Concern - an independently owned and operated concern certified, or certifiable, as a small business by the Federal Small Business Administration (SBA). Standard Industrial Classification (SIC) codes may be found in the Federal Acquisition Regulations, Section 19.102 or in the Federal Procurement Regulations, Section 1-1.701.

Small Disadvantaged or Minority Business Concern - a small business concern which is at least fifty-one percent (51%) owned by one or more socially and economically disadvantaged individuals or in the case of any publicly owned business, at least fifty-one percent (51%) of the stock of which is owned by such individuals; and whose management and daily business operations are controlled by one or more of such individuals. Business owners who certify that they are members of named groups (Black Americans, Hispanic Americans, Native Americans, Asian-Pacific Americans) are considered socially and economically disadvantaged.

Woman-Owned Business - a business concern that is at least fifty-one percent (51%) owned by a woman or women who also control and operate it. "Control" in this context means exercising the power to make policy decisions. "Operate" in this context means being actively involved in the day-to-day management.

c) Race/Ethnicity of Ownership (check one) based on definitions below.

Black Asian/Pacific or Asian/Indian Caucasian
 Hispanic Native American (American Indians, Eskimos, Aleuts and native Hawaiians)

ETHNIC GROUP DEFINITIONS

Black Americans: United States citizens whose origins are in any of the Black racial groups of Africa.
Hispanic Americans: United States citizens whose origins are in Mexico, Puerto Rico, Cuba, Portugal, Central or Central America.
Native Americans: United States citizens whose origins are in any of the original peoples of North America, i.e., American Indians, Eskimos, Aleuts and native Hawaiians.
Asian Pacific/Asian Indian Americans: United States citizens whose origins are in Japan, China, Korea, Taiwan, Cambodia, Laos, Vietnam, the Philippines, Samoa, Guam, the U.S. Trust Territories of the Pacific Islands, the Northern Mariana Islands, India, Pakistan, or Bangladesh.

I certify that the business classification and ethnicity indicated above reflects the true and correct status of this business in accordance with current Federal Small Business Administration criteria. I agree to inform Community High School District 99 immediately in writing of any changes to the information contained herein, including changes in ownership, controlling interest or operations. I understand that falsely certifying this information may result in suspension from participation in Community High School District 99 – 2021 Capital Projects North & South

Name: _____ Title: _____
(Print or Type)

Signature: _____ Date: _____

END OF SECTION 004101

BID DATE: February 18th at 10:00 a.m. (CST)
(via Building Connected)

BID TO: Community High School District 99
Administrative Center
6301 Springside Avenue
Downers Grove, IL 60516

RECEIVED BY:

BID FROM: _____

BID FOR: Bid Group 1 - Bid Package #08 - HVAC
Transition Building
4232 Venard Road
Downers Grove, IL 60516

THE UNDERSIGNED:

Acknowledges receipt of:

Plans and specifications for the work indicated above.

Addenda: No. _____ dated _____
No. _____ dated _____
No. _____ dated _____
No. _____ dated _____

Having examined the site of the work, and having familiarized himself or herself with local conditions affecting the cost of the work and with all requirements of the bidding documents including Instructions to Bidders, drawings, specifications and duly issued addenda as prepared by the architect, Wight & Company, hereby agrees to perform all work and furnish all labor, material and equipment specifically required of him by the bidding documents and such additional work as may be included as related requirements in other divisions or sections of the specifications, exclusive of alternate bids.

Agrees:

To furnish and install the described material and/or services for stated lump sum price.

To hold this bid open until **90** calendar days after bid opening date.

To accept the provisions of the General Provisions (Project Manual Division 0 – Bidding & Contracting Requirements

Section 00201) and disposition of bid security.

To enter into and execute a contract with the Owner, if awarded on the basis of this bid, and in connection therewith to:

1. Furnish all bonds and insurance required by the bidding documents.
2. Accomplish the work in accordance with the contract.
3. Complete the work within the contract time herein specified.

Completion Time:

The undersigned agrees to begin construction immediately, or as directed by the Construction Manager, upon notice of contract award and to perform the following components of the work in accordance with the Construction Manager's Construction. This schedule is bound in the Project Manual. See attached scope of work in section 0300.

SCOPE OF WORK:

The work in this agreement (without additional compensation) shall include, but shall not necessarily be limited to, all skilled labor, supervision, premium time, materials, tools, equipment, plant, supplies, samples, shop drawings, design/engineering drawings, layout, transportation, supervision, contributions, insurance, taxes (if applicable), compliance with all agencies (City / Village, County, State, Federal and/or any other jurisdictional agency, as may be required) and/or all services and facilities necessary and/or required for the performance of all Work shown, detailed, and/or implied by the following documents and as defined herein.

It is understood that this Trade Contractor shall perform the Work for a complete and operational system as indicated or implied in all Contract Documents. It is recognized and understood that the documents upon which the bid is based are at a conceptual phase and this Contractor who has certain skills and judgments based upon his knowledge of techniques, procedures, systems, general state of the art of his specialty is expected to include in the scope of work, all items required in order to carry out a complete and functional system whether or not shown or described in the contract documents. This contract will be awarded on the basis of such documents with the understanding that this contractor is to furnish and install all items required for the proper completion of this work without adjustment to this contract price. No extra payments shall be made of claims entertained as a result of such items, unless it can be clearly demonstrated to be added scope to the contract and beyond the original intent of the documents.

Contractor to provide all Trade Contract work referenced in:

1. Any sheet of this bid group package including (reference Division 0 – Bidding and Contract Requirements, Section 00200 – Notice to Bidders).
2. Specification 00300 Bid Packages Scope Document.

WORK BASE BID: For providing all work including all allowances as required for the completion of the construction of the base bid project as shown on the drawings and specifications and NOT including alternate bids and/or contractor's proposed alternates and substitutes.

BASE BID

TOTAL BASE BID AMOUNT **TRANSITION BUILDING BUILD OUT:**

_____ Dollars (\$ _____)

1. This TRADE CONTRACTOR **shall include an allowance of \$15,000.00 in their base bid** to account for any unforeseen conditions. Contract amounts will be adjusted by change order for amounts greater or less than the allowance. Allowance to be utilized only at the direction of Construction Manager.

BONDS:

This TRADE CONTRACTOR will be required to provide a Performance and Payment Bond for their work in accordance with 00201 of the General Conditions.

Award Basis:

The project will be awarded based upon the attached Evaluation Criteria, Section 301a. Owner and Construction Manager alternate's may be considered to find the most qualified bidder if the result of combining the base bid and the selected alternate(s) is the most qualified bid, and is to the benefit of the owner.

Each of the following amounts for alternate construction includes the entire cost of such construction, except as otherwise noted. Acceptance of any or all of the alternates for inclusion in the contract is the sole prerogative of the owner.

All additional costs due to the alternates are included in the amount to be added to the base bid, so that no additional costs will be borne by the owner due to acceptance of alternates. This alternate price is not to be included in the base bid price.

Owner Requested Alternates:

Each of the following amounts for alternate construction includes the entire cost of such construction, except as otherwise noted. Acceptance of any or all of the alternates for inclusion in the contract is the sole prerogative of the owner.

All additional costs due to the alternates are included in the amount to be added to the base bid, so that no additional costs will be borne by the owner due to acceptance of alternates.

Proposed Alternates: (Contractors Proposed Alternates)

Item Specified	Proposed Alternate	Change in Bid Price
1. _____	_____	_____
2. _____	_____	_____
3. _____	_____	_____

Owner Requested Unit Prices/Allowances (as applicable to this Trade Contractor's scope of work) (additive or deductive).

This trade contractor includes _____ dumpsters for all refuse caused by this trade contractor's work in the amount of _____ Dollars (\$_____) Note: trade contractors are to include in their bid form submittal the quantity of dumpsters required to complete their work and the cost associated with same. Dumpster costs will be subtracted by change order. Dumpsters will be procured and managed by Construction Manager. Note: Dumpster use in excess of that proposed by this Trade Contractor will be adjusted by back charge.

Owner Requested Scheduling Information:

Note: The work of this Trade Contractor is to be completed in accordance with the overall project schedule as identified elsewhere in this project manual and/or as subsequently directed by Construction Manager. This Trade Contractor shall

submit a proposed submittals list/schedule/material log within five (5) calendar days of Notice To Proceed.

1. Shop drawings / Submittal for this trade contractor will be submitted within 10 calendar days of receipt of notice to proceed.

Bid Acceptance:

If written notice of the acceptance of this bid is mailed, telegraphed or delivered to the undersigned within the time noted herein, after the date of opening of bids or at any time thereafter before this bid is withdrawn, the undersigned agrees that he will execute a construction contract in accordance with the bids as accepted.

The Owner reserves the right to award the contract to its best interests, review and accept any and all value engineering alternatives, negotiate with the lowest responsible bidder, to reject any or all bids, to waive any informalities in bidding and to hold all bids for the bid guarantee period. The Owner reserves the right to award separate contracts for any of the items of work bid herein.

Bid Deposit:

The undersigned furnishes herewith, as required in the Instructions to Bidders, a bid deposit in the amount of ten percent (10%) of the amount bid in the form of Cashier's Check, or Certified Check, made payable to the Owner or Bid Bond, naming the Owner as obligee. (Bidder to check form of deposit furnished.)

It is understood and agreed that should the undersigned fail to enter into a contract with the Owner or furnish acceptable contract security within the time and in the manner herein provided, the bid deposit shall be retained by the Owner as liquidated damages and not as a forfeiture. As it is impossible to determine precisely an exact amount of damages the Owner will sustain, it is agreed that the bid deposit is a fair and equitable estimate of such damages.

REPRESENTATIONS AND CERTIFICATIONS:

The bidder makes the following representations and certifications as part of his bid on the project herein identified in the Bid Form. In the case of a joint venture bid, each party represents and certifies as to his own organization.

AVAILABILITY. The number and amount of contracts and awards pending which I am and/or will be obligated to perform, now and during the course of the project, will not interfere with or hinder the timely prosecution of my work.

SURETY. I have notified a Surety Company that I am submitting a bid for work to be performed on the project. The Surety Company has agreed to issue a performance and labor and material payment bond for my work, if my bid is accepted and the contract awarded to me.

INDEPENDENT PRICE DETERMINATION. The contract sum in this bid has been arrived at independently, without consultation, communication or agreement for the purpose of restricting competition.

PREVAILING WAGE. The contractor and each subcontractor shall pay not less than the general prevailing rate of hourly wages for work of a similar character in the locality in which the work is performed and not less than general prevailing rate of hourly wages for legal holidays and overtime work in the performance of work under this contract, as established by the Illinois Department of Labor, pursuant to an act of the General Assembly of the State of Illinois approved June 26, 1941 as amended according to Section 820 ILCS 130/1.

Pursuant to Section 820 ILCS 130/5, the contractor and each subcontractor shall keep an accurate record showing the names and occupation of all laborers, workers and mechanics employed by them, and also showing the actual hourly wages paid to each such individual, which record shall be open at all reasonable hours to inspection by the Owner, its officers and agents, and to agents of the Illinois Department of Labor.

The contractor and each subcontractor hereby agree, jointly and severally, to defend, indemnify and hold harmless the Owner from any and all claims, demands, liens or suits of any kind or nature whatsoever (including suits for injunctive relief) by the Illinois Department of Labor under the Illinois Prevailing Wage Act, Section 820 ILCS 130/1., or by any laborer, worker or mechanic employed by the contractor or the subcontractor who alleges that he has been paid for his services in a sum less than prevailing wage rates required by Illinois law. The Owner agrees to notify the contractor or subcontractor of the pendency of any such claim, demand, lien or suit.

By submitting a bid, each bidder agrees to waive any claim it has or may have against the Owner, the Architect, Engineer, Construction Manager and their respective employees, arising out of or in connection with the administration, evaluation, or recommendation of any bid; waiver of any requirements under the Bid Documents; or the Contract Document; acceptance or rejection of any bids; and award of the Contract.

Signature:

Respectfully submitted this _____ day _____, 2021

Type of Firm (Bidder to indicate)

_____ Individual

_____ Partnership

_____ Corporation

_____ Joint Venture

_____ Other

(CORPORATE SEAL)

(Firm Name)

(Address)

(Telephone Number)

(FAX)

(E-mail Address)

(Bidder's Signature)

(Title)

Subscribed and sworn to me
this . day of __, 2020

NOTE: All pages of this bid form must be returned with your proposal. Failure to do so shall disqualify your bid.

CERTIFICATE OF BIDDER ELIGIBILITY

720 ILCS 5/33E-11 REQUIRES THAT ALL CONTRACTORS BIDDING FOR PUBLIC AGENCIES IN THE State of Illinois certify that they are not barred from bidding on public contracts for bid rigging or bid rotation.

The following certification must be signed and submitted with bidder's bid proposal. FAILURE TO DO SO MAY RESULT IN DISQUALIFICATION OF THE BIDDER.

_____, as part of its bid for the _____ work for Community High School District 99, Downers Grove, Illinois, DuPage County, Illinois certified that said contractor is not barred from bidding on the aforementioned contract as a result of violation of either 720 ILCS 5/33E-3 or 720 ILCS 5/33-E4.

Firm: _____

By: _____
(Signature)

(Printed Name & Title)

SUBSCRIBED AND SWORN TO before me

This _____ day of _____, 202

NOTARY PUBLIC

**CRIMINAL CODE CERTIFICATION
AS REQUIRED BY:
STATE OF ILLINOIS CRIMINAL CODE OF 2012, 720 ILCS 5/33E-11**

I, _____ the individual whose signature appears below on this bid/contract
for _____ hereby certify that the bidding party/contracting party
is not barred from bidding on the contract as a result of a violation of either Section 33E-3 or Section 33E-4 of 720 ILCS 5/33E-
3 or 5/33E-4 of the Illinois Compiled Statutes, as amended.

By: _____
Authorized Agent of Contractor (name and title)

SUBSCRIBED AND SWORN to before
me this ____ day _____, 20__.

Notary Public

EQUAL EMPLOYMENT OPPORTUNITY

Section I. This EQUAL EMPLOYMENT OPPORTUNITY CLAUSE is required by the Illinois Human Rights Act and the Rules and Regulations of the Illinois Department of Human Rights published at 44 Illinois Administrative Code Section 750, *et seq.*

Section II. In the event of the Contractor's noncompliance with any provision of this Equal Employment Opportunity Clause, the Illinois Human Rights Act, or the Rules and Regulations of the Department of Human Rights (hereinafter referred to as the Department) the Contractor may be declared ineligible for future contracts or subcontracts with the State of Illinois or any of its political subdivisions or municipal corporations, and this Contract may be canceled or voided in whole or in part, and other sanctions or penalties may be imposed or remedies involved as provided by statute or regulation.

During the performance of this Agreement, the Contractor agrees:

A. That it will not discriminate against any employee or applicant for employment because of race, color, religion, sex, sexual orientation, national origin or ancestry, citizenship status, age, physical or mental disability unrelated to ability, military status or an unfavorable discharge from military service; and further that it will examine all job classifications to determine if minority persons or women are underutilized and will take appropriate affirmative action to rectify any such underutilization.

B. That, if it hires additional employees in order to perform this Contract, or any portion hereof, it will determine the availability (in accordance with the Department's Rules and Regulations) of minorities and women in the area(s) from which it may reasonably recruit and it will hire for each job classification for which employees are hired in such a way that minorities and women are not underutilized.

C. That, in all solicitations or advertisements for employees placed by it or on its behalf, it will state that all applicants will be afforded equal opportunity without discrimination because of race, color, religion, sex, sexual orientation, marital status, national origin or ancestry, citizenship status, age, or physical or mental handicap unrelated to ability, military status or an unfavorable discharge from military service.

D. That it will send to each labor organization or representative of workers with which it has or is bound by a collective bargaining or other agreement or understanding, a notice advising such labor organization or representative of the Vendor's obligations under the Illinois Human Rights Act and Department's Rules and Regulations. If any labor organization or representative fails or refuses to cooperate with the Contractor in its efforts to comply with the Act and Rules and Regulations, the Contractor will promptly notify the Department and the contracting agency and will recruit employees from other sources when necessary to fulfill its obligations under the Contract.

E. That it will submit reports as required by the Department's Rules and Regulations, furnish all relevant information as may from time to time be requested by the Department or the contracting agency, and in all respects comply with the Illinois Human Rights Act and Department's Rules and Regulations.

F. That it will permit access to all relevant books, records, accounts and work sites by personnel of the contracting agency and Department for purposes of investigation to ascertain compliance with the Illinois Human Rights Act and Department's Rules and Regulations.

G. That it will include verbatim or by reference the provisions of this Equal Employment Opportunity Clause in every subcontract it awards under which any portion of this Contract obligations are undertaken or assumed, so that such provisions will be binding upon such subcontractor. In the same manner as the other provisions of this Agreement, the Contractor will be liable for compliance with applicable provisions of this clause by such subcontractors; and further it will promptly notify the contracting agency and the Department in the event any subcontractor fails or refuses to comply therewith. In addition, the Contractor will not utilize any subcontractor declared by the Illinois Human Rights Department to be ineligible for contracts or subcontracts with the State of Illinois or any of its political subdivisions or municipal corporations.

ACKNOWLEDGED AND AGREED TO:

By: _____
Authorized Agent of Contractor (name and title)

DATE: _____

SEXUAL HARASSMENT POLICY

_____, having submitted a bid for _____ (Name of Contractor)
_____ to Community High School District No. 00, hereby certifies that
said contractor has a written sexual harassment policy in place in full compliance with 775 ILCS 5/2-105 (A) (4).

By: _____
Authorized Agent of Contractor (name and title)

SUBSCRIBED AND SWORN to before
me this ____ day _____, 20__.

Notary Public

TAX CERTIFICATION

I, _____, having been first duly sworn depose and state as follows:

I, _____, am the duly authorized agent for
High School District No. 99 for

_____ and I hereby certify that _____ is not delinquent in the payment of any tax administered by the Illinois Department of Revenue, or if it is:

a. it is contesting its liability for the tax or the amount of tax in accordance with procedures established by the appropriate Revenue Act; or

b. it has entered into an agreement with the Department of Revenue for payment of all taxes due and is currently in compliance with that agreement.

By: _____
Authorized Agent of Contractor (name and title)

SUBSCRIBED AND SWORN to before
me this ____ day _____, 20__.

Notary Public

SUBSTANCE ABUSE PREVENTION ON PUBLIC WORKS PROJECTS

The Contractor certifies that it has in place a written program that meets or exceeds the program requirements of the Substance Abuse Prevention on Public Works Projects Act (Public Act 95-0635), and will provide a copy thereof to Community High School District No. 99 prior to commencement of work on the Project.

By: _____
Authorized Agent of Contractor (name and title)

SUBSCRIBED AND SWORN to before
me this ____ day _____, 20__.

Notary Public

**CERTIFICATE REGARDING
EMPLOYMENT OF ILLINOIS WORKERS ON PUBLIC WORKS**

_____ agrees if at the time the Agreement is executed, or if during the term of the Agreement, there is excessive unemployment in Illinois as defined in the Employment of Illinois Workers on Public Works Act, 30- ILCS 570/0/01 et seq., as two consecutive months of unemployment exceeding 5%, then _____ agrees to employ Illinois laborers in accordance with the Employment of Illinois Workers on Public Works Act. An "Illinois laborer" is defined as any person who has resided in Illinois for at least thirty (30) days and intends to become or remain an Illinois resident.

Firm: _____

By: _____
(Signature)

(Printed Name & Title)

SUBSCRIBED AND SWORN TO before me

This _____ day of _____, 2021

NOTARY PUBLIC

PREVAILING WAGE AFFIDAVIT

AFFIDAVIT: "I (we) hereby certify and affirm that if awarded a contract with Community High School District 99, we will comply fully with the "Illinois Prevailing Wage Act (Ill. Rev. Stat., 1987 Ch. 48, Sections 398 s-1-12 as amended by Public Act 86-693 and 86-799 effected January 1, 1990, and any other amendments effective thereafter)". We further understand that current prevailing wage standards are included in the Supplementary General Conditions.

The following affidavit must be signed and submitted with bidder's bid proposal. FAILURE TO DO SO MAY RESULT IN DISQUALIFICATION OF THE BIDDER.

_____, as part of its bid for the _____ work for Community High School District 99, Downers Grove, Illinois, certifies that said contractor is not barred from bidding on the aforementioned contract as a result of a violation of the Illinois Prevailing Wage Act (Ill. Rev. Stat., 1987 Ch. 48, Sections 398 s-1-12 as amended by Public Act 86-693 and 86-799 effected January 1, 1990).

Firm: _____

By: _____

(Signature)

(Printed Name & Title)

SUBSCRIBED AND SWORN TO before me

This _____ day of _____, 2021

NOTARY PUBLIC

NON-COLLUSION AFFIDAVIT

AFFIDAVIT: "I (we) hereby certify and affirm that my (our) proposal was prepared independently for this project and that it contains no fees or amounts other than that for the legitimate execution of this work as specified and that it includes no understanding or agreements in restraint of trade."

The following affidavit must be signed and submitted with bidder's bid proposal.
FAILURE TO DO SO MAY RESULT IN DISQUALIFICATION OF THE BIDDER.

_____, as a part of its bid for the _____ work for Community High School District 99, Downers Grove, Illinois, certifies that said Contractor is not barred from bidding on the aforementioned contract as a result of a violation of the above Non-Collusion Affidavit.

Firm: _____

By: _____
(Signature)

(Printed Name & Title)

SUBSCRIBED AND SWORN TO before me

This _____ day of _____, 2021

NOTARY PUBLIC

Criminal Background Investigations

Contractor hereby represents, warrants and certified that no officer or director thereof has any knowledge that any employee thereof has been convicted of committing or attempting to commit "Criminal Code of 1961," 720 ILCS, Sections 5/11-6 (Indecent solicitation of a child), 5/11-9 (Public indecency), 5/11-14 (Prostitution), 5/11-15 (Soliciting for a prostitute), 5/11-15.1 (Soliciting for a juvenile prostitute), 5/11-19 (Pimping), 5/11-19.1 (Juvenile pimping), 5/11-19.2 (Exploitation of a child), 5/11-20 (Obscenity), 5/11-20.1 (Sexual assault), 5/12-14 (Aggravated criminal sexual assault), 5/12-15 (Criminal sexual abuse), and 5/120-16 (Aggravated criminal sexual abuse), and/or those offenses defined in the "Cannabis Control Act," 720 ILCS, 550/1 et seq. (except the "Illinois Controlled Substances Act," 720 ILCS 570/100 et seq. and/or any offense committed or attempted in any other state or against the laws of the United States, which if committed or attempted in this State, would have been punishable as one or more of the foregoing offenses.

Contractor further agrees that it shall not employ any person who have or may have direct, daily contact with the pupils of any school in the district, and for whom a criminal background investigation has not been conducted pursuant hereto, and further represents and agrees that all applicants for any such employment shall furnish with their applications the attached written "Authorization for Criminal Background Information" form authorizing the Board of Education to request a criminal background investigation of said applicant pursuant to Section 5/10-21.9 of the School Code of Illinois and to receive criminal history record information pursuant thereto to determine if the applicant has been convicted of committing or attempting to commit any of the criminal or drug offenses enumerated above. Contractor further agrees to submit with said authorization payment for any costs and expenses associated with the criminal background investigation.

Contractor further represents, warrants, and certifies that no applicant for employment with respect to whom the criminal investigation reveals any conviction for committing and/or attempting to commit any of the above enumerated offenses shall be employed thereby in any position that involves or may involve contact with the students of the school district.

This certification is executed on the date hereinafter indicated by the designated contractor by its duly authorized officer.

Firm: _____

By: _____
(Signature)

(Printed Name & Title)

Date: _____

Criminal Background Investigation

The undersigned hereby authorizes in Board of Education of Community High School District 99, Downers Grove, Illinois, to request a criminal background investigation from the Illinois State Police, pursuant to Section 5/10-21.9 of the School Code of Illinois, 105 ILCS 5/10-21.9 and to receive criminal history record information pursuant thereto.

By: _____
(Signature of Applicant of Employee)

(Printed or Typed Name of Applicant Employee)

Date: _____

BUSINESS CLASSIFICATION

a) Business Entity (check one)

Corporation (Publicly held)* Not-for-Profit* Government Agency/Public Institution*
 Corporation (Privately held) Partnership Sole Proprietor

* If checked, do not complete section III (b) and (c) below.

b) Business Ownership (check one) If minority or woman owned, attach copy of certification evidence.

Large Business: Male Owned Woman Owned
Small Business: Male Owned Woman Owned

BUSINESS DEFINITIONS

Small Business Concern - an independently owned and operated concern certified, or certifiable, as a small business by the Federal Small Business Administration (SBA). Standard Industrial Classification (SIC) codes may be found in the Federal Acquisition Regulations, Section 19.102 or in the Federal Procurement Regulations, Section 1-1.701.

Small Disadvantaged or Minority Business Concern - a small business concern which is at least fifty-one percent (51%) owned by one or more socially and economically disadvantaged individuals or in the case of any publicly owned business, at least fifty-one percent (51%) of the stock of which is owned by such individuals; and whose management and daily business operations are controlled by one or more of such individuals. Business owners who certify that they are members of named groups (Black Americans, Hispanic Americans, Native Americans, Asian-Pacific Americans) are considered socially and economically disadvantaged.

Woman-Owned Business - a business concern that is at least fifty-one percent (51%) owned by a woman or women who also control and operate it. "Control" in this context means exercising the power to make policy decisions. "Operate" in this context means being actively involved in the day-to-day management.

c) Race/Ethnicity of Ownership (check one) based on definitions below.

Black Asian/Pacific or Asian/Indian Caucasian
 Hispanic Native American (American Indians, Eskimos, Aleuts and native Hawaiians)

ETHNIC GROUP DEFINITIONS

Black Americans: United States citizens whose origins are in any of the Black racial groups of Africa.
Hispanic Americans: United States citizens whose origins are in Mexico, Puerto Rico, Cuba, Portugal, Central or Central America.
Native Americans: United States citizens whose origins are in any of the original peoples of North America, i.e., American Indians, Eskimos, Aleuts and native Hawaiians.
Asian Pacific/Asian Indian Americans: United States citizens whose origins are in Japan, China, Korea, Taiwan, Cambodia, Laos, Vietnam, the Philippines, Samoa, Guam, the U.S. Trust Territories of the Pacific Islands, the Northern Mariana Islands, India, Pakistan, or Bangladesh.

I certify that the business classification and ethnicity indicated above reflects the true and correct status of this business in accordance with current Federal Small Business Administration criteria. I agree to inform Community High School District 99 immediately in writing of any changes to the information contained herein, including changes in ownership, controlling interest or operations. I understand that falsely certifying this information may result in suspension from participation in Community High School District 99 – 2021 Capital Projects North & South

Name: _____ Title: _____
(Print or Type)

Signature: _____ Date: _____

END OF SECTION 004101

BID DATE: February 18th at 10:00 a.m. (CST)
(via Building Connected)

BID TO: Community High School District 99
Administrative Center
6301 Springside Avenue
Downers Grove, IL 60516

RECEIVED BY:

BID FROM: _____

BID FOR: Bid Group 1 - Bid Package #09 - Electrical
Transition Building
4232 Venard Road
Downers Grove, IL 60516

THE UNDERSIGNED:

Acknowledges receipt of:

Plans and specifications for the work indicated above.

Addenda: No. _____ dated _____
No. _____ dated _____
No. _____ dated _____
No. _____ dated _____

Having examined the site of the work, and having familiarized himself or herself with local conditions affecting the cost of the work and with all requirements of the bidding documents including Instructions to Bidders, drawings, specifications and duly issued addenda as prepared by the architect, Wight & Company, hereby agrees to perform all work and furnish all labor, material and equipment specifically required of him by the bidding documents and such additional work as may be included as related requirements in other divisions or sections of the specifications, exclusive of alternate bids.

Agrees:

To furnish and install the described material and/or services for stated lump sum price.

To hold this bid open until **90** calendar days after bid opening date.

To accept the provisions of the General Provisions (Project Manual Division 0 – Bidding & Contracting Requirements

Section 00201) and disposition of bid security.

To enter into and execute a contract with the Owner, if awarded on the basis of this bid, and in connection therewith to:

1. Furnish all bonds and insurance required by the bidding documents.
2. Accomplish the work in accordance with the contract.
3. Complete the work within the contract time herein specified.

Completion Time:

The undersigned agrees to begin construction immediately, or as directed by the Construction Manager, upon notice of contract award and to perform the following components of the work in accordance with the Construction Manager's Construction. This schedule is bound in the Project Manual. See attached scope of work in section 0300.

SCOPE OF WORK:

The work in this agreement (without additional compensation) shall include, but shall not necessarily be limited to, all skilled labor, supervision, premium time, materials, tools, equipment, plant, supplies, samples, shop drawings, design/engineering drawings, layout, transportation, supervision, contributions, insurance, taxes (if applicable), compliance with all agencies (City / Village, County, State, Federal and/or any other jurisdictional agency, as may be required) and/or all services and facilities necessary and/or required for the performance of all Work shown, detailed, and/or implied by the following documents and as defined herein.

It is understood that this Trade Contractor shall perform the Work for a complete and operational system as indicated or implied in all Contract Documents. It is recognized and understood that the documents upon which the bid is based are at a conceptual phase and this Contractor who has certain skills and judgments based upon his knowledge of techniques, procedures, systems, general state of the art of his specialty is expected to include in the scope of work, all items required in order to carry out a complete and functional system whether or not shown or described in the contract documents. This contract will be awarded on the basis of such documents with the understanding that this contractor is to furnish and install all items required for the proper completion of this work without adjustment to this contract price. No extra payments shall be made of claims entertained as a result of such items, unless it can be clearly demonstrated to be added scope to the contract and beyond the original intent of the documents.

Contractor to provide all Trade Contract work referenced in:

1. Any sheet of this bid group package including (reference Division 0 – Bidding and Contract Requirements, Section 00200 – Notice to Bidders).
2. Specification 00300 Bid Packages Scope Document.

WORK BASE BID: For providing all work including all allowances as required for the completion of the construction of the base bid project as shown on the drawings and specifications and NOT including alternate bids and/or contractor's proposed alternates and substitutes.

BASE BID

TOTAL BASE BID AMOUNT **TRANSITION BUILDING BUILD OUT:**

_____ Dollars (\$ _____)

1. This TRADE CONTRACTOR **shall include an allowance of \$10,000.00 in their base bid** to account for any unforeseen conditions. Contract amounts will be adjusted by change order for amounts greater or less than the allowance. Allowance to be utilized only at the direction of Construction Manager.

BONDS:

This TRADE CONTRACTOR will be required to provide a Performance and Payment Bond for their work in accordance with 00201 of the General Conditions.

Award Basis:

The project will be awarded based upon the attached Evaluation Criteria, Section 301a. Owner and Construction Manager alternate's may be considered to find the most qualified bidder if the result of combining the base bid and the selected alternate(s) is the most qualified bid, and is to the benefit of the owner.

Each of the following amounts for alternate construction includes the entire cost of such construction, except as otherwise noted. Acceptance of any or all of the alternates for inclusion in the contract is the sole prerogative of the owner.

All additional costs due to the alternates are included in the amount to be added to the base bid, so that no additional costs will be borne by the owner due to acceptance of alternates. This alternate price is not to be included in the base bid price.

Owner Requested Alternates:

Each of the following amounts for alternate construction includes the entire cost of such construction, except as otherwise noted. Acceptance of any or all of the alternates for inclusion in the contract is the sole prerogative of the owner.

All additional costs due to the alternates are included in the amount to be added to the base bid, so that no additional costs will be borne by the owner due to acceptance of alternates.

Proposed Alternates: (Contractors Proposed Alternates)

Item Specified	Proposed Alternate	Change in Bid Price
1. _____	_____	_____
2. _____	_____	_____
3. _____	_____	_____

Owner Requested Unit Prices/Allowances (as applicable to this Trade Contractor's scope of work) (additive or deductive).

This trade contractor includes _____ dumpsters for all refuse caused by this trade contractor's work in the amount of _____ Dollars (\$_____) Note: trade contractors are to include in their bid form submittal the quantity of dumpsters required to complete their work and the cost associated with same. Dumpster costs will be subtracted by change order. Dumpsters will be procured and managed by Construction Manager. Note: Dumpster use in excess of that proposed by this Trade Contractor will be adjusted by back charge.

Owner Requested Scheduling Information:

Note: The work of this Trade Contractor is to be completed in accordance with the overall project schedule as identified elsewhere in this project manual and/or as subsequently directed by Construction Manager. This Trade Contractor shall

submit a proposed submittals list/schedule/material log within five (5) calendar days of Notice To Proceed.

1. Shop drawings / Submittal for this trade contractor will be submitted within 10 calendar days of receipt of notice to proceed.

Bid Acceptance:

If written notice of the acceptance of this bid is mailed, telegraphed or delivered to the undersigned within the time noted herein, after the date of opening of bids or at any time thereafter before this bid is withdrawn, the undersigned agrees that he will execute a construction contract in accordance with the bids as accepted.

The Owner reserves the right to award the contract to its best interests, review and accept any and all value engineering alternatives, negotiate with the lowest responsible bidder, to reject any or all bids, to waive any informalities in bidding and to hold all bids for the bid guarantee period. The Owner reserves the right to award separate contracts for any of the items of work bid herein.

Bid Deposit:

The undersigned furnishes herewith, as required in the Instructions to Bidders, a bid deposit in the amount of ten percent (10%) of the amount bid in the form of Cashier's Check, or Certified Check, made payable to the Owner or Bid Bond, naming the Owner as obligee. (Bidder to check form of deposit furnished.)

It is understood and agreed that should the undersigned fail to enter into a contract with the Owner or furnish acceptable contract security within the time and in the manner herein provided, the bid deposit shall be retained by the Owner as liquidated damages and not as a forfeiture. As it is impossible to determine precisely an exact amount of damages the Owner will sustain, it is agreed that the bid deposit is a fair and equitable estimate of such damages.

REPRESENTATIONS AND CERTIFICATIONS:

The bidder makes the following representations and certifications as part of his bid on the project herein identified in the Bid Form. In the case of a joint venture bid, each party represents and certifies as to his own organization.

AVAILABILITY. The number and amount of contracts and awards pending which I am and/or will be obligated to perform, now and during the course of the project, will not interfere with or hinder the timely prosecution of my work.

SURETY. I have notified a Surety Company that I am submitting a bid for work to be performed on the project. The Surety Company has agreed to issue a performance and labor and material payment bond for my work, if my bid is accepted and the contract awarded to me.

INDEPENDENT PRICE DETERMINATION. The contract sum in this bid has been arrived at independently, without consultation, communication or agreement for the purpose of restricting competition.

PREVAILING WAGE. The contractor and each subcontractor shall pay not less than the general prevailing rate of hourly wages for work of a similar character in the locality in which the work is performed and not less than general prevailing rate of hourly wages for legal holidays and overtime work in the performance of work under this contract, as established by the Illinois Department of Labor, pursuant to an act of the General Assembly of the State of Illinois approved June 26, 1941 as amended according to Section 820 ILCS 130/1.

Pursuant to Section 820 ILCS 130/5, the contractor and each subcontractor shall keep an accurate record showing the names and occupation of all laborers, workers and mechanics employed by them, and also showing the actual hourly wages paid to each such individual, which record shall be open at all reasonable hours to inspection by the Owner, its officers and agents, and to agents of the Illinois Department of Labor.

The contractor and each subcontractor hereby agree, jointly and severally, to defend, indemnify and hold harmless the Owner from any and all claims, demands, liens or suits of any kind or nature whatsoever (including suits for injunctive relief) by the Illinois Department of Labor under the Illinois Prevailing Wage Act, Section 820 ILCS 130/1., or by any laborer, worker or mechanic employed by the contractor or the subcontractor who alleges that he has been paid for his services in a sum less than prevailing wage rates required by Illinois law. The Owner agrees to notify the contractor or subcontractor of the pendency of any such claim, demand, lien or suit.

By submitting a bid, each bidder agrees to waive any claim it has or may have against the Owner, the Architect, Engineer, Construction Manager and their respective employees, arising out of or in connection with the administration, evaluation, or recommendation of any bid; waiver of any requirements under the Bid Documents; or the Contract Document; acceptance or rejection of any bids; and award of the Contract.

Signature:

Respectfully submitted this _____ day _____, 2021

Type of Firm (Bidder to indicate)

_____ Individual

_____ Partnership

_____ Corporation

_____ Joint Venture

_____ Other

(CORPORATE SEAL)

(Firm Name)

(Address)

(Telephone Number)

(FAX)

(E-mail Address)

(Bidder's Signature)

(Title)

Subscribed and sworn to me
this . day of __, 2020

NOTE: All pages of this bid form must be returned with your proposal. Failure to do so shall disqualify your bid.

CERTIFICATE OF BIDDER ELIGIBILITY

720 ILCS 5/33E-11 REQUIRES THAT ALL CONTRACTORS BIDDING FOR PUBLIC AGENCIES IN THE State of Illinois certify that they are not barred from bidding on public contracts for bid rigging or bid rotation.

The following certification must be signed and submitted with bidder's bid proposal. FAILURE TO DO SO MAY RESULT IN DISQUALIFICATION OF THE BIDDER.

_____, as part of its bid for the _____ work for Community High School District 99, Downers Grove, Illinois, DuPage County, Illinois certified that said contractor is not barred from bidding on the aforementioned contract as a result of violation of either 720 ILCS 5/33E-3 or 720 ILCS 5/33-E4.

Firm: _____

By: _____
(Signature)

(Printed Name & Title)

SUBSCRIBED AND SWORN TO before me

This _____ day of _____, 202

NOTARY PUBLIC

**CRIMINAL CODE CERTIFICATION
AS REQUIRED BY:
STATE OF ILLINOIS CRIMINAL CODE OF 2012, 720 ILCS 5/33E-11**

I, _____ the individual whose signature appears below on this bid/contract
for _____ hereby certify that the bidding party/contracting party
is not barred from bidding on the contract as a result of a violation of either Section 33E-3 or Section 33E-4 of 720 ILCS 5/33E-3 or 5/33E-4 of the Illinois Compiled Statutes, as amended.

By: _____
Authorized Agent of Contractor (name and title)

SUBSCRIBED AND SWORN to before
me this ____ day _____, 20__.

Notary Public

EQUAL EMPLOYMENT OPPORTUNITY

Section I. This EQUAL EMPLOYMENT OPPORTUNITY CLAUSE is required by the Illinois Human Rights Act and the Rules and Regulations of the Illinois Department of Human Rights published at 44 Illinois Administrative Code Section 750, *et seq.*

Section II. In the event of the Contractor's noncompliance with any provision of this Equal Employment Opportunity Clause, the Illinois Human Rights Act, or the Rules and Regulations of the Department of Human Rights (hereinafter referred to as the Department) the Contractor may be declared ineligible for future contracts or subcontracts with the State of Illinois or any of its political subdivisions or municipal corporations, and this Contract may be canceled or voided in whole or in part, and other sanctions or penalties may be imposed or remedies involved as provided by statute or regulation.

During the performance of this Agreement, the Contractor agrees:

A. That it will not discriminate against any employee or applicant for employment because of race, color, religion, sex, sexual orientation, national origin or ancestry, citizenship status, age, physical or mental disability unrelated to ability, military status or an unfavorable discharge from military service; and further that it will examine all job classifications to determine if minority persons or women are underutilized and will take appropriate affirmative action to rectify any such underutilization.

B. That, if it hires additional employees in order to perform this Contract, or any portion hereof, it will determine the availability (in accordance with the Department's Rules and Regulations) of minorities and women in the area(s) from which it may reasonably recruit and it will hire for each job classification for which employees are hired in such a way that minorities and women are not underutilized.

C. That, in all solicitations or advertisements for employees placed by it or on its behalf, it will state that all applicants will be afforded equal opportunity without discrimination because of race, color, religion, sex, sexual orientation, marital status, national origin or ancestry, citizenship status, age, or physical or mental handicap unrelated to ability, military status or an unfavorable discharge from military service.

D. That it will send to each labor organization or representative of workers with which it has or is bound by a collective bargaining or other agreement or understanding, a notice advising such labor organization or representative of the Vendor's obligations under the Illinois Human Rights Act and Department's Rules and Regulations. If any labor organization or representative fails or refuses to cooperate with the Contractor in its efforts to comply with the Act and Rules and Regulations, the Contractor will promptly notify the Department and the contracting agency and will recruit employees from other sources when necessary to fulfill its obligations under the Contract.

E. That it will submit reports as required by the Department's Rules and Regulations, furnish all relevant information as may from time to time be requested by the Department or the contracting agency, and in all respects comply with the Illinois Human Rights Act and Department's Rules and Regulations.

F. That it will permit access to all relevant books, records, accounts and work sites by personnel of the contracting agency and Department for purposes of investigation to ascertain compliance with the Illinois Human Rights Act and Department's Rules and Regulations.

G. That it will include verbatim or by reference the provisions of this Equal Employment Opportunity Clause in every subcontract it awards under which any portion of this Contract obligations are undertaken or assumed, so that such provisions will be binding upon such subcontractor. In the same manner as the other provisions of this Agreement, the Contractor will be liable for compliance with applicable provisions of this clause by such subcontractors; and further it will promptly notify the contracting agency and the Department in the event any subcontractor fails or refuses to comply therewith. In addition, the Contractor will not utilize any subcontractor declared by the Illinois Human Rights Department to be ineligible for contracts or subcontracts with the State of Illinois or any of its political subdivisions or municipal corporations.

ACKNOWLEDGED AND AGREED TO:

By: _____
Authorized Agent of Contractor (name and title)

DATE: _____

SEXUAL HARASSMENT POLICY

_____, having submitted a bid for _____ (Name of Contractor)
_____ to Community High School District No. 00, hereby certifies that
said contractor has a written sexual harassment policy in place in full compliance with 775 ILCS 5/2-105 (A) (4).

By: _____
Authorized Agent of Contractor (name and title)

SUBSCRIBED AND SWORN to before
me this ____ day _____, 20__.

Notary Public

TAX CERTIFICATION

I, _____, having been first duly sworn depose and state as follows:

I, _____, am the duly authorized agent for
High School District No. 99 which has submitted a proposal to Community for

_____ and I hereby certify that _____ is not delinquent in the payment of any tax administered by the Illinois Department of Revenue, or if it is:

a. it is contesting its liability for the tax or the amount of tax in accordance with procedures established by the appropriate Revenue Act; or

b. it has entered into an agreement with the Department of Revenue for payment of all taxes due and is currently in compliance with that agreement.

By: _____
Authorized Agent of Contractor (name and title)

SUBSCRIBED AND SWORN to before
me this ____ day _____, 20__.

Notary Public

SUBSTANCE ABUSE PREVENTION ON PUBLIC WORKS PROJECTS

The Contractor certifies that it has in place a written program that meets or exceeds the program requirements of the Substance Abuse Prevention on Public Works Projects Act (Public Act 95-0635), and will provide a copy thereof to Community High School District No. 99 prior to commencement of work on the Project.

By: _____
Authorized Agent of Contractor (name and title)

SUBSCRIBED AND SWORN to before
me this ____ day _____, 20__.

Notary Public

**CERTIFICATE REGARDING
EMPLOYMENT OF ILLINOIS WORKERS ON PUBLIC WORKS**

_____ agrees if at the time the Agreement is executed, or if during the term of the Agreement, there is excessive unemployment in Illinois as defined in the Employment of Illinois Workers on Public Works Act, 30- ILCS 570/0/01 et seq., as two consecutive months of unemployment exceeding 5%, then _____ agrees to employ Illinois laborers in accordance with the Employment of Illinois Workers on Public Works Act. An "Illinois laborer" is defined as any person who has resided in Illinois for at least thirty (30) days and intends to become or remain an Illinois resident.

Firm: _____

By: _____
(Signature)

(Printed Name & Title)

SUBSCRIBED AND SWORN TO before me

This _____ day of _____, 2021

NOTARY PUBLIC

PREVAILING WAGE AFFIDAVIT

AFFIDAVIT: "I (we) hereby certify and affirm that if awarded a contract with Community High School District 99, we will comply fully with the "Illinois Prevailing Wage Act (Ill. Rev. Stat., 1987 Ch. 48, Sections 398 s-1-12 as amended by Public Act 86-693 and 86-799 effected January 1, 1990, and any other amendments effective thereafter)". We further understand that current prevailing wage standards are included in the Supplementary General Conditions.

The following affidavit must be signed and submitted with bidder's bid proposal. FAILURE TO DO SO MAY RESULT IN DISQUALIFICATION OF THE BIDDER.

_____, as part of its bid for the _____ work for Community High School District 99, Downers Grove, Illinois, certifies that said contractor is not barred from bidding on the aforementioned contract as a result of a violation of the Illinois Prevailing Wage Act (Ill. Rev. Stat., 1987 Ch. 48, Sections 398 s-1-12 as amended by Public Act 86-693 and 86-799 effected January 1, 1990).

Firm: _____

By: _____
(Signature)

(Printed Name & Title)

SUBSCRIBED AND SWORN TO before me

This _____ day of _____, 2021

NOTARY PUBLIC

NON-COLLUSION AFFIDAVIT

AFFIDAVIT: "I (we) hereby certify and affirm that my (our) proposal was prepared independently for this project and that it contains no fees or amounts other than that for the legitimate execution of this work as specified and that it includes no understanding or agreements in restraint of trade."

The following affidavit must be signed and submitted with bidder's bid proposal.
FAILURE TO DO SO MAY RESULT IN DISQUALIFICATION OF THE BIDDER.

_____, as a part of its bid for the _____ work for Community High School District 99, Downers Grove, Illinois, certifies that said Contractor is not barred from bidding on the aforementioned contract as a result of a violation of the above Non-Collusion Affidavit.

Firm: _____

By: _____
(Signature)

(Printed Name & Title)

SUBSCRIBED AND SWORN TO before me

This _____ day of _____, 2021

NOTARY PUBLIC

Criminal Background Investigations

Contractor hereby represents, warrants and certified that no officer or director thereof has any knowledge that any employee thereof has been convicted of committing or attempting to commit "Criminal Code of 1961," 720 ILCS, Sections 5/11-6 (Indecent solicitation of a child), 5/11-9 (Public indecency), 5/11-14 (Prostitution), 5/11-15 (Soliciting for a prostitute), 5/11-15.1 (Soliciting for a juvenile prostitute), 5/11-19 (Pimping), 5/11-19.1 (Juvenile pimping), 5/11-19.2 (Exploitation of a child), 5/11-20 (Obscenity), 5/11-20.1 (Sexual assault), 5/12-14 (Aggravated criminal sexual assault), 5/12-15 (Criminal sexual abuse), and 5/120-16 (Aggravated criminal sexual abuse), and/or those offenses defined in the "Cannabis Control Act," 720 ILCS, 550/1 et seq. (except the "Illinois Controlled Substances Act," 720 ILCS 570/100 et seq. and/or any offense committed or attempted in any other state or against the laws of the United States, which if committed or attempted in this State, would have been punishable as one or more of the foregoing offenses.

Contractor further agrees that it shall not employ any person who have or may have direct, daily contact with the pupils of any school in the district, and for whom a criminal background investigation has not been conducted pursuant hereto, and further represents and agrees that all applicants for any such employment shall furnish with their applications the attached written "Authorization for Criminal Background Information" form authorizing the Board of Education to request a criminal background investigation of said applicant pursuant to Section 5/10-21.9 of the School Code of Illinois and to receive criminal history record information pursuant thereto to determine if the applicant has been convicted of committing or attempting to commit any of the criminal or drug offenses enumerated above. Contractor further agrees to submit with said authorization payment for any costs and expenses associated with the criminal background investigation.

Contractor further represents, warrants, and certifies that no applicant for employment with respect to whom the criminal investigation reveals any conviction for committing and/or attempting to commit any of the above enumerated offenses shall be employed thereby in any position that involves or may involve contact with the students of the school district.

This certification is executed on the date hereinafter indicated by the designated contractor by its duly authorized officer.

Firm: _____

By: _____
(Signature)

(Printed Name & Title)

Date: _____

Criminal Background Investigation

The undersigned hereby authorizes in Board of Education of Community High School District 99, Downers Grove, Illinois, to request a criminal background investigation from the Illinois State Police, pursuant to Section 5/10-21.9 of the School Code of Illinois, 105 ILCS 5/10-21.9 and to receive criminal history record information pursuant thereto.

By: _____
(Signature of Applicant of Employee)

(Printed or Typed Name of Applicant Employee)

Date: _____

BUSINESS CLASSIFICATION

a) Business Entity (check one)

Corporation (Publicly held)* Not-for-Profit* Government Agency/Public Institution*
 Corporation (Privately held) Partnership Sole Proprietor

* If checked, do not complete section III (b) and (c) below.

b) Business Ownership (check one) If minority or woman owned, attach copy of certification evidence.

Large Business: Male Owned Woman Owned
Small Business: Male Owned Woman Owned

BUSINESS DEFINITIONS

Small Business Concern - an independently owned and operated concern certified, or certifiable, as a small business by the Federal Small Business Administration (SBA). Standard Industrial Classification (SIC) codes may be found in the Federal Acquisition Regulations, Section 19.102 or in the Federal Procurement Regulations, Section 1-1.701.

Small Disadvantaged or Minority Business Concern - a small business concern which is at least fifty-one percent (51%) owned by one or more socially and economically disadvantaged individuals or in the case of any publicly owned business, at least fifty-one percent (51%) of the stock of which is owned by such individuals; and whose management and daily business operations are controlled by one or more of such individuals. Business owners who certify that they are members of named groups (Black Americans, Hispanic Americans, Native Americans, Asian-Pacific Americans) are considered socially and economically disadvantaged.

Woman-Owned Business - a business concern that is at least fifty-one percent (51%) owned by a woman or women who also control and operate it. "Control" in this context means exercising the power to make policy decisions. "Operate" in this context means being actively involved in the day-to-day management.

c) Race/Ethnicity of Ownership (check one) based on definitions below.

Black Asian/Pacific or Asian/Indian Caucasian
 Hispanic Native American (American Indians, Eskimos, Aleuts and native Hawaiians)

ETHNIC GROUP DEFINITIONS

Black Americans: United States citizens whose origins are in any of the Black racial groups of Africa.
Hispanic Americans: United States citizens whose origins are in Mexico, Puerto Rico, Cuba, Portugal, Central or Central America.
Native Americans: United States citizens whose origins are in any of the original peoples of North America, i.e., American Indians, Eskimos, Aleuts and native Hawaiians.
Asian Pacific/Asian Indian Americans: United States citizens whose origins are in Japan, China, Korea, Taiwan, Cambodia, Laos, Vietnam, the Philippines, Samoa, Guam, the U.S. Trust Territories of the Pacific Islands, the Northern Mariana Islands, India, Pakistan, or Bangladesh.

I certify that the business classification and ethnicity indicated above reflects the true and correct status of this business in accordance with current Federal Small Business Administration criteria. I agree to inform Community High School District 99 immediately in writing of any changes to the information contained herein, including changes in ownership, controlling interest or operations. I understand that falsely certifying this information may result in suspension from participation in Community High School District 99 – 2021 Capital Projects North & South

Name: _____ Title: _____
(Print or Type)

Signature: _____ Date: _____

END OF SECTION 004101

BID DATE: February 18th at 10:00 a.m. (CST)
(via Building Connected)

BID TO: Community High School District 99
Administrative Center
6301 Springside Avenue
Downers Grove, IL 60516

RECEIVED BY:

BID FROM: _____

BID FOR: Bid Group 1 - Bid Package #10 – Acoustical Ceilings
***Transition Building
4232 Venard Road
Downers Grove, IL 60516***

THE UNDERSIGNED:

Acknowledges receipt of:

Plans and specifications for the work indicated above.

Addenda: No. _____ dated _____
No. _____ dated _____
No. _____ dated _____
No. _____ dated _____

Having examined the site of the work, and having familiarized himself or herself with local conditions affecting the cost of the work and with all requirements of the bidding documents including Instructions to Bidders, drawings, specifications and duly issued addenda as prepared by the architect, Wight & Company, hereby agrees to perform all work and furnish all labor, material and equipment specifically required of him by the bidding documents and such additional work as may be included as related requirements in other divisions or sections of the specifications, exclusive of alternate bids.

Agrees:

To furnish and install the described material and/or services for stated lump sum price.

To hold this bid open until **90** calendar days after bid opening date.

To accept the provisions of the General Provisions (Project Manual Division 0 – Bidding & Contracting Requirements

Section 00201) and disposition of bid security.

To enter into and execute a contract with the Owner, if awarded on the basis of this bid, and in connection therewith to:

1. Furnish all bonds and insurance required by the bidding documents.
2. Accomplish the work in accordance with the contract.
3. Complete the work within the contract time herein specified.

Completion Time:

The undersigned agrees to begin construction immediately, or as directed by the Construction Manager, upon notice of contract award and to perform the following components of the work in accordance with the Construction Manager's Construction. This schedule is bound in the Project Manual. See attached scope of work in section 0300.

SCOPE OF WORK:

The work in this agreement (without additional compensation) shall include, but shall not necessarily be limited to, all skilled labor, supervision, premium time, materials, tools, equipment, plant, supplies, samples, shop drawings, design/engineering drawings, layout, transportation, supervision, contributions, insurance, taxes (if applicable), compliance with all agencies (City / Village, County, State, Federal and/or any other jurisdictional agency, as may be required) and/or all services and facilities necessary and/or required for the performance of all Work shown, detailed, and/or implied by the following documents and as defined herein.

It is understood that this Trade Contractor shall perform the Work for a complete and operational system as indicated or implied in all Contract Documents. It is recognized and understood that the documents upon which the bid is based are at a conceptual phase and this Contractor who has certain skills and judgments based upon his knowledge of techniques, procedures, systems, general state of the art of his specialty is expected to include in the scope of work, all items required in order to carry out a complete and functional system whether or not shown or described in the contract documents. This contract will be awarded on the basis of such documents with the understanding that this contractor is to furnish and install all items required for the proper completion of this work without adjustment to this contract price. No extra payments shall be made of claims entertained as a result of such items, unless it can be clearly demonstrated to be added scope to the contract and beyond the original intent of the documents.

Contractor to provide all Trade Contract work referenced in:

1. Any sheet of this bid group package including (reference Division 0 – Bidding and Contract Requirements, Section 00200 – Notice to Bidders).
2. Specification 00300 Bid Packages Scope Document.

WORK BASE BID: For providing all work including all allowances as required for the completion of the construction of the base bid project as shown on the drawings and specifications and NOT including alternate bids and/or contractor's proposed alternates and substitutes.

BASE BID

TOTAL BASE BID AMOUNT **TRANSITION BUILDING BUILD OUT:**

_____ Dollars (\$ _____)

1. This TRADE CONTRACTOR **shall include an allowance of \$5,000.00 in their base bid** to account for any unforeseen conditions. Contract amounts will be adjusted by change order for amounts greater or less than the allowance. Allowance to be utilized only at the direction of Construction Manager.

BONDS:

This TRADE CONTRACTOR will be required to provide a Performance and Payment Bond for their work in accordance with 00201 of the General Conditions.

Award Basis:

The project will be awarded based upon the attached Evaluation Criteria, Section 301a. Owner and Construction Manager alternate's may be considered to find the most qualified bidder if the result of combining the base bid and the selected alternate(s) is the most qualified bid, and is to the benefit of the owner.

Each of the following amounts for alternate construction includes the entire cost of such construction, except as otherwise noted. Acceptance of any or all of the alternates for inclusion in the contract is the sole prerogative of the owner.

All additional costs due to the alternates are included in the amount to be added to the base bid, so that no additional costs will be borne by the owner due to acceptance of alternates. This alternate price is not to be included in the base bid price.

Owner Requested Alternates:

Each of the following amounts for alternate construction includes the entire cost of such construction, except as otherwise noted. Acceptance of any or all of the alternates for inclusion in the contract is the sole prerogative of the owner.

All additional costs due to the alternates are included in the amount to be added to the base bid, so that no additional costs will be borne by the owner due to acceptance of alternates.

Proposed Alternates: (Contractors Proposed Alternates)

Item Specified	Proposed Alternate	Change in Bid Price
1. _____	_____	_____
2. _____	_____	_____
3. _____	_____	_____

Owner Requested Unit Prices/Allowances (as applicable to this Trade Contractor's scope of work) (additive or deductive).

This trade contractor includes _____ dumpsters for all refuse caused by this trade contractor's work in the amount of _____ Dollars (\$_____) Note: trade contractors are to include in their bid form submittal the quantity of dumpsters required to complete their work and the cost associated with same. Dumpster costs will be subtracted by change order. Dumpsters will be procured and managed by Construction Manager. Note: Dumpster use in excess of that proposed by this Trade Contractor will be adjusted by back charge.

Owner Requested Scheduling Information:

Note: The work of this Trade Contractor is to be completed in accordance with the overall project schedule as identified elsewhere in this project manual and/or as subsequently directed by Construction Manager. This Trade Contractor shall submit a proposed submittals list/schedule/material log within five (5) calendar days of Notice To Proceed.

1. Shop drawings / Submittal for this trade contractor will be submitted within 10 calendar days of receipt of notice to proceed.

Bid Acceptance:

If written notice of the acceptance of this bid is mailed, telegraphed or delivered to the undersigned within the time noted herein, after the date of opening of bids or at any time thereafter before this bid is withdrawn, the undersigned agrees that he will execute a construction contract in accordance with the bids as accepted.

The Owner reserves the right to award the contract to its best interests, review and accept any and all value engineering alternatives, negotiate with the lowest responsible bidder, to reject any or all bids, to waive any informalities in bidding and to hold all bids for the bid guarantee period. The Owner reserves the right to award separate contracts for any of the items of work bid herein.

Bid Deposit:

The undersigned furnishes herewith, as required in the Instructions to Bidders, a bid deposit in the amount of ten percent (10%) of the amount bid in the form of Cashier's Check, or Certified Check, made payable to the Owner or Bid Bond, naming the Owner as obligee. (Bidder to check form of deposit furnished.)

It is understood and agreed that should the undersigned fail to enter into a contract with the Owner or furnish acceptable contract security within the time and in the manner herein provided, the bid deposit shall be retained by the Owner as liquidated damages and not as a forfeiture. As it is impossible to determine precisely an exact amount of damages the Owner will sustain, it is agreed that the bid deposit is a fair and equitable estimate of such damages.

REPRESENTATIONS AND CERTIFICATIONS:

The bidder makes the following representations and certifications as part of his bid on the project herein identified in the Bid Form. In the case of a joint venture bid, each party represents and certifies as to his own organization.

AVAILABILITY. The number and amount of contracts and awards pending which I am and/or will be obligated to perform, now and during the course of the project, will not interfere with or hinder the timely prosecution of my work.

SURETY. I have notified a Surety Company that I am submitting a bid for work to be performed on the project. The Surety Company has agreed to issue a performance and labor and material payment bond for my work, if my bid is accepted and the contract awarded to me.

INDEPENDENT PRICE DETERMINATION. The contract sum in this bid has been arrived at independently, without consultation, communication or agreement for the purpose of restricting competition.

PREVAILING WAGE. The contractor and each subcontractor shall pay not less than the general prevailing rate of hourly wages for work of a similar character in the locality in which the work is performed and not less than general prevailing rate of hourly wages for legal holidays and overtime work in the performance of work under this contract, as established by the Illinois Department of Labor, pursuant to an act of the General Assembly of the State of Illinois approved June 26, 1941 as amended according to Section 820 ILCS 130/1.

Pursuant to Section 820 ILCS 130/5, the contractor and each subcontractor shall keep an accurate record showing the names and occupation of all laborers, workers and mechanics employed by them, and also showing the actual hourly wages paid to each such individual, which record shall be open at all reasonable hours to inspection by the Owner, its officers and agents, and to agents of the Illinois Department of Labor.

The contractor and each subcontractor hereby agree, jointly and severally, to defend, indemnify and hold harmless the Owner from any and all claims, demands, liens or suits of any kind or nature whatsoever (including suits for injunctive relief) by the Illinois Department of Labor under the Illinois Prevailing Wage Act, Section 820 ILCS 130/1., or by any laborer, worker or mechanic employed by the contractor or the subcontractor who alleges that he has been paid for his services in a sum less than prevailing wage rates required by Illinois law. The Owner agrees to notify the contractor or subcontractor of the pendency of any such claim, demand, lien or suit.

By submitting a bid, each bidder agrees to waive any claim it has or may have against the Owner, the Architect, Engineer, Construction Manager and their respective employees, arising out of or in connection with the administration, evaluation, or recommendation of any bid; waiver of any requirements under the Bid Documents; or the Contract Document; acceptance or rejection of any bids; and award of the Contract.

Signature:

Respectfully submitted this _____ day _____, 2021

Type of Firm (Bidder to indicate)

_____ Individual

_____ Partnership

_____ Corporation

_____ Joint Venture

_____ Other

(CORPORATE SEAL)

(Firm Name)

(Address)

(Telephone Number)

(FAX)

(E-mail Address)

(Bidder's Signature)

(Title)

Subscribed and sworn to me
this . day of __, 2020

NOTE: All pages of this bid form must be returned with your proposal. Failure to do so shall disqualify your bid.

CERTIFICATE OF BIDDER ELIGIBILITY

720 ILCS 5/33E-11 REQUIRES THAT ALL CONTRACTORS BIDDING FOR PUBLIC AGENCIES IN THE State of Illinois certify that they are not barred from bidding on public contracts for bid rigging or bid rotation.

The following certification must be signed and submitted with bidder's bid proposal. FAILURE TO DO SO MAY RESULT IN DISQUALIFICATION OF THE BIDDER.

_____, as part of its bid for the _____ work for Community High School District 99, Downers Grove, Illinois, DuPage County, Illinois certified that said contractor is not barred from bidding on the aforementioned contract as a result of violation of either 720 ILCS 5/33E-3 or 720 ILCS 5/33-E4.

Firm: _____

By: _____
(Signature)

(Printed Name & Title)

SUBSCRIBED AND SWORN TO before me

This _____ day of _____, 202

NOTARY PUBLIC

**CRIMINAL CODE CERTIFICATION
AS REQUIRED BY:
STATE OF ILLINOIS CRIMINAL CODE OF 2012, 720 ILCS 5/33E-11**

I, _____ the individual whose signature appears below on this bid/contract
for _____ hereby certify that the bidding party/contracting party
is not barred from bidding on the contract as a result of a violation of either Section 33E-3 or Section 33E-4 of 720 ILCS 5/33E-
3 or 5/33E-4 of the Illinois Compiled Statutes, as amended.

By: _____
Authorized Agent of Contractor (name and title)

SUBSCRIBED AND SWORN to before
me this ____ day _____, 20__.

Notary Public

EQUAL EMPLOYMENT OPPORTUNITY

Section I. This EQUAL EMPLOYMENT OPPORTUNITY CLAUSE is required by the Illinois Human Rights Act and the Rules and Regulations of the Illinois Department of Human Rights published at 44 Illinois Administrative Code Section 750, *et seq.*

Section II. In the event of the Contractor's noncompliance with any provision of this Equal Employment Opportunity Clause, the Illinois Human Rights Act, or the Rules and Regulations of the Department of Human Rights (hereinafter referred to as the Department) the Contractor may be declared ineligible for future contracts or subcontracts with the State of Illinois or any of its political subdivisions or municipal corporations, and this Contract may be canceled or voided in whole or in part, and other sanctions or penalties may be imposed or remedies involved as provided by statute or regulation.

During the performance of this Agreement, the Contractor agrees:

A. That it will not discriminate against any employee or applicant for employment because of race, color, religion, sex, sexual orientation, national origin or ancestry, citizenship status, age, physical or mental disability unrelated to ability, military status or an unfavorable discharge from military service; and further that it will examine all job classifications to determine if minority persons or women are underutilized and will take appropriate affirmative action to rectify any such underutilization.

B. That, if it hires additional employees in order to perform this Contract, or any portion hereof, it will determine the availability (in accordance with the Department's Rules and Regulations) of minorities and women in the area(s) from which it may reasonably recruit and it will hire for each job classification for which employees are hired in such a way that minorities and women are not underutilized.

C. That, in all solicitations or advertisements for employees placed by it or on its behalf, it will state that all applicants will be afforded equal opportunity without discrimination because of race, color, religion, sex, sexual orientation, marital status, national origin or ancestry, citizenship status, age, or physical or mental handicap unrelated to ability, military status or an unfavorable discharge from military service.

D. That it will send to each labor organization or representative of workers with which it has or is bound by a collective bargaining or other agreement or understanding, a notice advising such labor organization or representative of the Vendor's obligations under the Illinois Human Rights Act and Department's Rules and Regulations. If any labor organization or representative fails or refuses to cooperate with the Contractor in its efforts to comply with the Act and Rules and Regulations, the Contractor will promptly notify the Department and the contracting agency and will recruit employees from other sources when necessary to fulfill its obligations under the Contract.

E. That it will submit reports as required by the Department's Rules and Regulations, furnish all relevant information as may from time to time be requested by the Department or the contracting agency, and in all respects comply with the Illinois Human Rights Act and Department's Rules and Regulations.

F. That it will permit access to all relevant books, records, accounts and work sites by personnel of the contracting agency and Department for purposes of investigation to ascertain compliance with the Illinois Human Rights Act and Department's Rules and Regulations.

G. That it will include verbatim or by reference the provisions of this Equal Employment Opportunity Clause in every subcontract it awards under which any portion of this Contract obligations are undertaken or assumed, so that such provisions will be binding upon such subcontractor. In the same manner as the other provisions of this Agreement, the Contractor will be liable for compliance with applicable provisions of this clause by such subcontractors; and further it will promptly notify the contracting agency and the Department in the event any subcontractor fails or refuses to comply therewith. In addition, the Contractor will not utilize any subcontractor declared by the Illinois Human Rights Department to be ineligible for contracts or subcontracts with the State of Illinois or any of its political subdivisions or municipal corporations.

ACKNOWLEDGED AND AGREED TO:

By: _____
Authorized Agent of Contractor (name and title)

DATE: _____

SEXUAL HARASSMENT POLICY

_____, having submitted a bid for _____ (Name of Contractor)
_____ to Community High School District No. 00, hereby certifies that
said contractor has a written sexual harassment policy in place in full compliance with 775 ILCS 5/2-105 (A) (4).

By: _____
Authorized Agent of Contractor (name and title)

SUBSCRIBED AND SWORN to before
me this ____ day _____, 20__.

Notary Public

TAX CERTIFICATION

I, _____, having been first duly sworn depose and state as follows:

I, _____, am the duly authorized agent for
High School District No. 99 for

_____ and I hereby certify that _____ is not delinquent in the payment of any tax administered by the Illinois Department of Revenue, or if it is:

a. it is contesting its liability for the tax or the amount of tax in accordance with procedures established by the appropriate Revenue Act; or

b. it has entered into an agreement with the Department of Revenue for payment of all taxes due and is currently in compliance with that agreement.

By: _____
Authorized Agent of Contractor (name and title)

SUBSCRIBED AND SWORN to before
me this ____ day _____, 20__.

Notary Public

SUBSTANCE ABUSE PREVENTION ON PUBLIC WORKS PROJECTS

The Contractor certifies that it has in place a written program that meets or exceeds the program requirements of the Substance Abuse Prevention on Public Works Projects Act (Public Act 95-0635), and will provide a copy thereof to Community High School District No. 99 prior to commencement of work on the Project.

By: _____
Authorized Agent of Contractor (name and title)

SUBSCRIBED AND SWORN to before
me this ____ day _____, 20__.

Notary Public

**CERTIFICATE REGARDING
EMPLOYMENT OF ILLINOIS WORKERS ON PUBLIC WORKS**

_____ agrees if at the time the Agreement is executed, or if during the term of the Agreement, there is excessive unemployment in Illinois as defined in the Employment of Illinois Workers on Public Works Act, 30- ILCS 570/0/01 et seq., as two consecutive months of unemployment exceeding 5%, then _____ agrees to employ Illinois laborers in accordance with the Employment of Illinois Workers on Public Works Act. An "Illinois laborer" is defined as any person who has resided in Illinois for at least thirty (30) days and intends to become or remain an Illinois resident.

Firm: _____

By: _____
(Signature)

(Printed Name & Title)

SUBSCRIBED AND SWORN TO before me

This _____ day of _____, 2021

NOTARY PUBLIC

PREVAILING WAGE AFFIDAVIT

AFFIDAVIT: "I (we) hereby certify and affirm that if awarded a contract with Community High School District 99, we will comply fully with the "Illinois Prevailing Wage Act (Ill. Rev. Stat., 1987 Ch. 48, Sections 398 s-1-12 as amended by Public Act 86-693 and 86-799 effected January 1, 1990, and any other amendments effective thereafter)". We further understand that current prevailing wage standards are included in the Supplementary General Conditions.

The following affidavit must be signed and submitted with bidder's bid proposal. FAILURE TO DO SO MAY RESULT IN DISQUALIFICATION OF THE BIDDER.

_____, as part of its bid for the _____ work for Community High School District 99, Downers Grove, Illinois, certifies that said contractor is not barred from bidding on the aforementioned contract as a result of a violation of the Illinois Prevailing Wage Act (Ill. Rev. Stat., 1987 Ch. 48, Sections 398 s-1-12 as amended by Public Act 86-693 and 86-799 effected January 1, 1990).

Firm: _____

By: _____
(Signature)

(Printed Name & Title)

SUBSCRIBED AND SWORN TO before me

This _____ day of _____, 2021

NOTARY PUBLIC

NON-COLLUSION AFFIDAVIT

AFFIDAVIT: "I (we) hereby certify and affirm that my (our) proposal was prepared independently for this project and that it contains no fees or amounts other than that for the legitimate execution of this work as specified and that it includes no understanding or agreements in restraint of trade."

The following affidavit must be signed and submitted with bidder's bid proposal.
FAILURE TO DO SO MAY RESULT IN DISQUALIFICATION OF THE BIDDER.

_____, as a part of its bid for the _____ work for Community High School District 99, Downers Grove, Illinois, certifies that said Contractor is not barred from bidding on the aforementioned contract as a result of a violation of the above Non-Collusion Affidavit.

Firm: _____

By: _____
(Signature)

(Printed Name & Title)

SUBSCRIBED AND SWORN TO before me

This _____ day of _____, 2021

NOTARY PUBLIC

Criminal Background Investigations

Contractor hereby represents, warrants and certified that no officer or director thereof has any knowledge that any employee thereof has been convicted of committing or attempting to commit "Criminal Code of 1961," 720 ILCS, Sections 5/11-6 (Indecent solicitation of a child), 5/11-9 (Public indecency), 5/11-14 (Prostitution), 5/11-15 (Soliciting for a prostitute), 5/11-15.1 (Soliciting for a juvenile prostitute), 5/11-19 (Pimping), 5/11-19.1 (Juvenile pimping), 5/11-19.2 (Exploitation of a child), 5/11-20 (Obscenity), 5/11-20.1 (Sexual assault), 5/12-14 (Aggravated criminal sexual assault), 5/12-15 (Criminal sexual abuse), and 5/120-16 (Aggravated criminal sexual abuse), and/or those offenses defined in the "Cannabis Control Act," 720 ILCS, 550/1 et seq. (except the "Illinois Controlled Substances Act," 720 ILCS 570/100 et seq. and/or any offense committed or attempted in any other state or against the laws of the United States, which if committed or attempted in this State, would have been punishable as one or more of the foregoing offenses.

Contractor further agrees that it shall not employ any person who have or may have direct, daily contact with the pupils of any school in the district, and for whom a criminal background investigation has not been conducted pursuant hereto, and further represents and agrees that all applicants for any such employment shall furnish with their applications the attached written "Authorization for Criminal Background Information" form authorizing the Board of Education to request a criminal background investigation of said applicant pursuant to Section 5/10-21.9 of the School Code of Illinois and to receive criminal history record information pursuant thereto to determine if the applicant has been convicted of committing or attempting to commit any of the criminal or drug offenses enumerated above. Contractor further agrees to submit with said authorization payment for any costs and expenses associated with the criminal background investigation.

Contractor further represents, warrants, and certifies that no applicant for employment with respect to whom the criminal investigation reveals any conviction for committing and/or attempting to commit any of the above enumerated offenses shall be employed thereby in any position that involves or may involve contact with the students of the school district.

This certification is executed on the date hereinafter indicated by the designated contractor by its duly authorized officer.

Firm: _____

By: _____
(Signature)

(Printed Name & Title)

Date: _____

Criminal Background Investigation

The undersigned hereby authorizes in Board of Education of Community High School District 99, Downers Grove, Illinois, to request a criminal background investigation from the Illinois State Police, pursuant to Section 5/10-21.9 of the School Code of Illinois, 105 ILCS 5/10-21.9 and to receive criminal history record information pursuant thereto.

By: _____
(Signature of Applicant of Employee)

(Printed or Typed Name of Applicant Employee)

Date: _____

BUSINESS CLASSIFICATION

a) Business Entity (check one)

Corporation (Publicly held)* Not-for-Profit* Government Agency/Public Institution*
 Corporation (Privately held) Partnership Sole Proprietor

* If checked, do not complete section III (b) and (c) below.

b) Business Ownership (check one) If minority or woman owned, attach copy of certification evidence.

Large Business: Male Owned Woman Owned
Small Business: Male Owned Woman Owned

BUSINESS DEFINITIONS

Small Business Concern - an independently owned and operated concern certified, or certifiable, as a small business by the Federal Small Business Administration (SBA). Standard Industrial Classification (SIC) codes may be found in the Federal Acquisition Regulations, Section 19.102 or in the Federal Procurement Regulations, Section 1-1.701.

Small Disadvantaged or Minority Business Concern - a small business concern which is at least fifty-one percent (51%) owned by one or more socially and economically disadvantaged individuals or in the case of any publicly owned business, at least fifty-one percent (51%) of the stock of which is owned by such individuals; and whose management and daily business operations are controlled by one or more of such individuals. Business owners who certify that they are members of named groups (Black Americans, Hispanic Americans, Native Americans, Asian-Pacific Americans) are considered socially and economically disadvantaged.

Woman-Owned Business - a business concern that is at least fifty-one percent (51%) owned by a woman or women who also control and operate it. "Control" in this context means exercising the power to make policy decisions. "Operate" in this context means being actively involved in the day-to-day management.

c) Race/Ethnicity of Ownership (check one) based on definitions below.

Black Asian/Pacific or Asian/Indian Caucasian
 Hispanic Native American (American Indians, Eskimos, Aleuts and native Hawaiians)

ETHNIC GROUP DEFINITIONS

Black Americans: United States citizens whose origins are in any of the Black racial groups of Africa.
Hispanic Americans: United States citizens whose origins are in Mexico, Puerto Rico, Cuba, Portugal, Central or Central America.
Native Americans: United States citizens whose origins are in any of the original peoples of North America, i.e., American Indians, Eskimos, Aleuts and native Hawaiians.
Asian Pacific/Asian Indian Americans: United States citizens whose origins are in Japan, China, Korea, Taiwan, Cambodia, Laos, Vietnam, the Philippines, Samoa, Guam, the U.S. Trust Territories of the Pacific Islands, the Northern Mariana Islands, India, Pakistan, or Bangladesh.

I certify that the business classification and ethnicity indicated above reflects the true and correct status of this business in accordance with current Federal Small Business Administration criteria. I agree to inform Community High School District 99 immediately in writing of any changes to the information contained herein, including changes in ownership, controlling interest or operations. I understand that falsely certifying this information may result in suspension from participation in Community High School District 99 – 2021 Capital Projects North & South

Name: _____ Title: _____
(Print or Type)

Signature: _____ Date: _____

END OF SECTION 004101

2/12/2021 8:08:25 AM
 C:\Users\jlsaski\Documents\200191_199_ARCH_2019_Central_slaski.rvt
 Wight & Co. © Copyright 2016. All rights reserved. No part of these documents may be reproduced, stored, or transmitted in any form or by any means, electronic, mechanical, photocopying, recording or otherwise, without the prior written consent of Wight & Co.

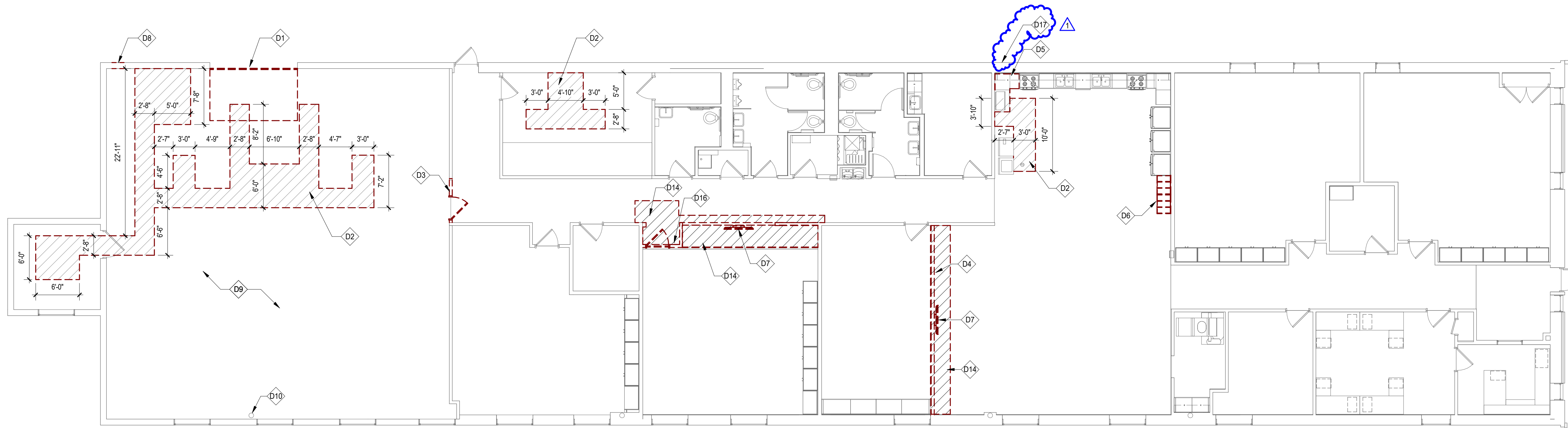

FLOOR PLAN LEGEND	
	EXISTING WALLS TO REMAIN.
	EXISTING WALLS TO BE DEMOLISHED.
	EXISTING DOOR TO REMAIN. REFER TO DOOR SCHEDULE FOR REQUIRED MODIFICATIONS.
	EXISTING DOOR TO BE DEMOLISHED.

DEMOLITION KEY NOTES	
D1	REMOVE AND DEMOLISH 12'-0" OVERHEAD DOOR AND FRAME. PREP OPENING FOR INFILL TO MATCH EXISTING MASONRY WALL CONSTRUCTION. SEE ELEVATIONS FOR MORE INFORMATION.
D2	REMOVE EXISTING CONCRETE SLAB AS REQUIRED FOR NEW UNDERGROUND PLUMBING.
D3	DEMOLISH PORTION OF 5" X 14'-0" HIGH GYPSUM AND METAL STUD WALL, INCLUDING DOOR, HARDWARE, AND FRAME.
D4	DEMOLISH 5" X 14'-0" HIGH GYPSUM AND METAL STUD WALL IN ITS ENTIRETY INCLUDING ANY MEP DEVICES/FIXTURES. REFER TO MEP PLANS AND SPECIFICATIONS FOR FURTHER INFORMATION ON DEVICE/FIXTURE TERMINATION.
D5	DEMOLISH EXISTING P-LAM COUNTERTOP.
D6	REMOVE AND RELOCATE EXISTING CUBBIES. PATCH WALL AS REQUIRED. SEE NEW PLAN FOR FINAL LOCATION.
D7	REMOVE, SALVAGE, AND REINSTALL SMARTBOARD. SEE NEW WORK PLANS.
D8	DEMOLISH PORTION OF EXISTING CMU WALL FOR NEW WALL LOUVER. PROVIDE WALL LINTEL AT OPENING AS INDICATED ON DRAWINGS. REFER TO MECHANICAL DRAWINGS FOR MORE INFORMATION.
D9	CONCRETE FLOOR EXISTING TO REMAIN. LEVEL DEPRESSED CONCRETE FLOOR AND PREP FOR NEW FLOORING.
D10	EXISTING ROOF DRAIN DOWNSPOUT TO REMAIN.
D14	DEMOLISH EXISTING FLOORING. PREP AS REQUIRED FOR INSTALLATION OF NEW. SEE FINISH PLANS.
D16	REMOVE AND SALVAGE SIGN. RETURN TO OWNER.
D17	DEMOLISH PORTION OF EXISTING CMU WALL FOR NEW VENT PIPING. PROVIDE WALL LINTEL AT OPENING AS INDICATED ON DRAWINGS. REFER TO MECHANICAL DRAWINGS FOR MORE INFORMATION.

1 DEMO FIRST FLOOR PLAN
 SCALE: 1/8" = 1'-0"



**COMMUNITY HIGH SCHOOL
 DISTRICT 99**



Wight & Company
 wightco.com
 2500 North Frontage Road
 Darien, IL 60561
 P 630.969.7000
 F 630.969.7979

NOT FOR
 CONSTRUCTION

REV	DESCRIPTION	DATE
1	ADDENDUM NO. 1	02/10/2021
	ISSUED FOR BID	01/15/2021
	75% CD	12/30/2020

**TRANSITION BUILDING
 BUILD-OUT**

4232 VENARD ROAD
 DOWNERS GROVE, IL 60516

DEMO FIRST FLOOR PLAN

Project Number:
 200191
 Drawn By:
 J.SLASKI
 Sheet:

AD2.01



COMMUNITY HIGH SCHOOL
DISTRICT 99



Wight & Company
wightco.com

2500 North Frontage Road
Darien, IL 60561

P 630.969.7000
F 630.969.7979

**NOT FOR
CONSTRUCTION**

1	ADDENDUM NO. 1	02/10/2021
	ISSUED FOR BID	01/15/2021
	75% CD	12/30/2020
REV	DESCRIPTION	DATE

TRANSITION BUILDING BUILD-OUT

4232 VENARD ROAD
DOWNERS GROVE, IL 60516

FIRST FLOOR PLAN

Project Number:
200191
Drawn By:
J.SLASKI
Sheet:

A2.01

- KEY NOTES**
1. PROVIDE BATT INSULATION ABOVE BOTTOM CORD OF STEEL BAR JOISTS. TAPE SEAMS. BETWEEN OPEN-WEB BAR JOISTS, RUN WIRE DIAGONALLY OR PERPENDICULAR AT 18" O.C. TO PREVENT SAGGING OF INSULATION. REFER TO SPECIFICATIONS AND WALL SECTIONS FOR MORE INFORMATION.
 2. NEW FLOOR FINISHES. PREP EXISTING FLOORS TO RECEIVE NEW FINISHES. PROVIDE FLOOR LEVELER AND UNDERLAYMENT AS REQUIRED. REFER TO FINISH PLANS.
 3. ROOM SHALL RECEIVE ALL NEW WALL BASE, WALL FINISH, AND CEILING FINISHES. REFER TO FINISH PLANS FOR ADDITIONAL INFORMATION.
 4. PROVIDE AND INSTALL 6'-0" X 5'-0" MAGNETIC MARKER BOARD.
 5. PROVIDE AND INSTALL 8'-0" X 5'-0" PROJECTION SCREEN COMPATIBLE WITH INTERACTIVE PROJECTOR, PROVIDED BY OWNER, INSTALLED BY CONTRACTOR.
 6. PROVIDE BLOCKING FOR DOOR WALL BUMPER.
 7. TOOTH-IN MASONRY AT REMOVED OVERHEAD DOOR AND FRAME, MATCH EXISTING COURSE USING WHOLE UNITS. PROVIDE REBAR @ 48" O.C., REFER TO WALL SECTIONS FOR MORE INFORMATION. APPLY (2) COATS OF BLOCK FILLER WITH (2) COATS MIN. EXTERIOR PAINT. COLOR SHALL MATCH EXISTING.
 8. PROVIDE AND INSTALL SEMI-RECESSED FIRE EXTINGUISHER CABINET.
 9. DISHWASHER FURNISHED AND INSTALLED BY OWNER.
 10. REFRIGERATOR FURNISHED AND INSTALLED BY OWNER.
 11. ROOM SHALL RECEIVE NEW WALL BASE AND WALL FINISH. REFER TO FINISH PLANS FOR ADDITIONAL INFORMATION.
 12. PROVIDE NEW FLOOR AND WALL BASE AS REQUIRED. PREP EXISTING FLOORS TO RECEIVE NEW FINISHES. PROVIDE FLOOR LEVELER AND UNDERLAYMENT AS REQUIRED. REFER TO FINISH PLANS.
 13. WALL MOUNTED SHORT THROW INTERACTIVE PROJECTOR PROVIDED BY OWNER. INSTALL BY CONTRACTOR.
 14. REINSTALL EXISTING SMARTBOARD.
 15. PATCH & PAINT WALL AS REQUIRED FOR NEW PLUMBING WORK. PAINT TO MATCH EXISTING.
 16. PROVIDE AND INSTALL ELECTRIC WALL HEATER. REFER TO MECHANICAL PLANS.
 17. NEW 4" CONCRETE CURB FOR MECHANICAL EQUIPMENT. COORDINATE LOCATION WITH MECHANICAL CONTRACTOR. SEE TYPICAL HOUSEKEEPING PAD DETAIL.
 18. POUR NEW CONCRETE SLAB AS REQUIRED IN TRENCHED AREA. TIE INTO EXISTING SLAB. SEE TYPICAL SLAB-ON-GRADE PATCH DETAIL. SEE DEMO PLAN FOR EXTENT.
 20. RELOCATED EXISTING CUBBIES.

- GENERAL NOTES**
1. ALL ITEMS THAT ARE TO BE REMOVED AND REINSTALLED OR SAVED ARE TO BE TAGGED AND CAREFULLY STORED (SEE OWNER FOR LOCATION).
 2. ALL AREAS AFFECTED BY DEMOLITION TO BE PATCHED, REPAIRED, & LEVELLED TO MATCH EXISTING ADJACENT SURFACE (MATCH EXISTING CONDITION AT DOOR JAMBS) VERIFY IN FIELD.
 3. THE CONSTRUCTION DOCUMENTS INDICATE THE OVERALL AREAS OF WORK. INCIDENTAL WORK ASSOCIATED BUT NOT SHOWN ON THE CONSTRUCTION DOCUMENTS MAY BE REQUIRED OUTSIDE THE PROJECT AREAS. THIS WORK IS PART OF THE CONSTRUCTION CONTRACT AND IS TO BE COMPLETED IN ACCORDANCE WITH THE CONTRACT REQUIREMENTS AT NO ADDITIONAL COST TO THE OWNER.
 4. ALL ITEMS INDICATED TO REMAIN ARE TO BE PROTECTED FROM DAMAGE. DAMAGED ITEMS ARE TO BE PATCHED & REPAIRED OR REPLACED AS REQUIRED TO MATCH ADJACENT LEVEL OF FINISH AND CONSTRUCTION, AT NO ADDITIONAL COST TO THE OWNER.
 5. WHEN THE REMOVAL OF EXISTING SURFACE MATERIAL IS REQUIRED TO COMPLETE CONTRACT WORK AND A NEW FINISH IS NOT SCHEDULED, PATCH/REPAIR AND PRIME THE AFFECTED SURFACE TO RECEIVE NEW FINISH.
 6. NEW SLEEVES AND OPENINGS IN THE EXISTING FLOOR, WALL & CEILING CONSTRUCTION ARE TO BE SEALED WITH FIRE SAFETY MATERIAL.
 7. ALL MISC. ITEMS (CHALKBOARDS, PENCIL SHARPENERS, ETC.) THAT INTERFERE WITH THE COMPLETION OF CONTRACT WORK BUT ARE NOT SHOWN TO BE REMOVED ARE TO BE REMOVED, STORED, AND REINSTALLED AT NO ADDITIONAL COST TO THE OWNER. IN THE EVENT THAT ITEMS CANNOT BE REINSTALLED IN ITS ORIGINAL LOCATION COORDINATE NEW LOCATION WITH ARCHITECT/OWNER.
 8. U.N.O. CONTRACTOR TO REMOVE EXISTING FLOORING AND BASE AS REQUIRED TO ACCOMMODATE DOOR ASSEMBLIES. PATCH/REPAIR AS NECESSARY TO MATCH ADJACENT SURFACES.
 9. REFER TO MEP-FP DRAWINGS FOR DEMOLITION / REMOVAL / RELOCATION AND INSTALLATION OF FIXTURES AND DEVICES.
 10. REFER TO SHEET A0.1 FOR TYPICAL FIXTURE MOUNTING HEIGHTS AND ADA COMPLAINT PLANS, ELEVATIONS, AND DETAILS.
 11. UPON REMOVAL OF DOORS, SHORE OPENINGS AS REQUIRED. SECURE ALL NEW FRAMES PER MANUFACTURERS RECOMMENDATIONS. PROVIDE LINTELS AS REQUIRED. SEE STRUCTURAL DRAWINGS.
 12. ON DOORS THAT ARE TO BE REMOVED RETURN ALL DOOR HARDWARE TO OWNER PRIOR TO DISPOSAL.
 13. ALL ELECTRICAL DEVICES & ASSEMBLIES BEING AFFECTED BY DEMO OF DOORS TO BE REINSTALLED AND RECONNECTED AT NO ADDITIONAL COST TO THE OWNER.
 14. ALL DIMENSIONS ARE TO OUTSIDE FACE OF WALL MATERIAL (GYPSUM BOARD OR MASONRY) UNLESS NOTED OTHERWISE.
 15. PATCH ROOF AS REQUIRED FOR ANY NEW PENETRATIONS.

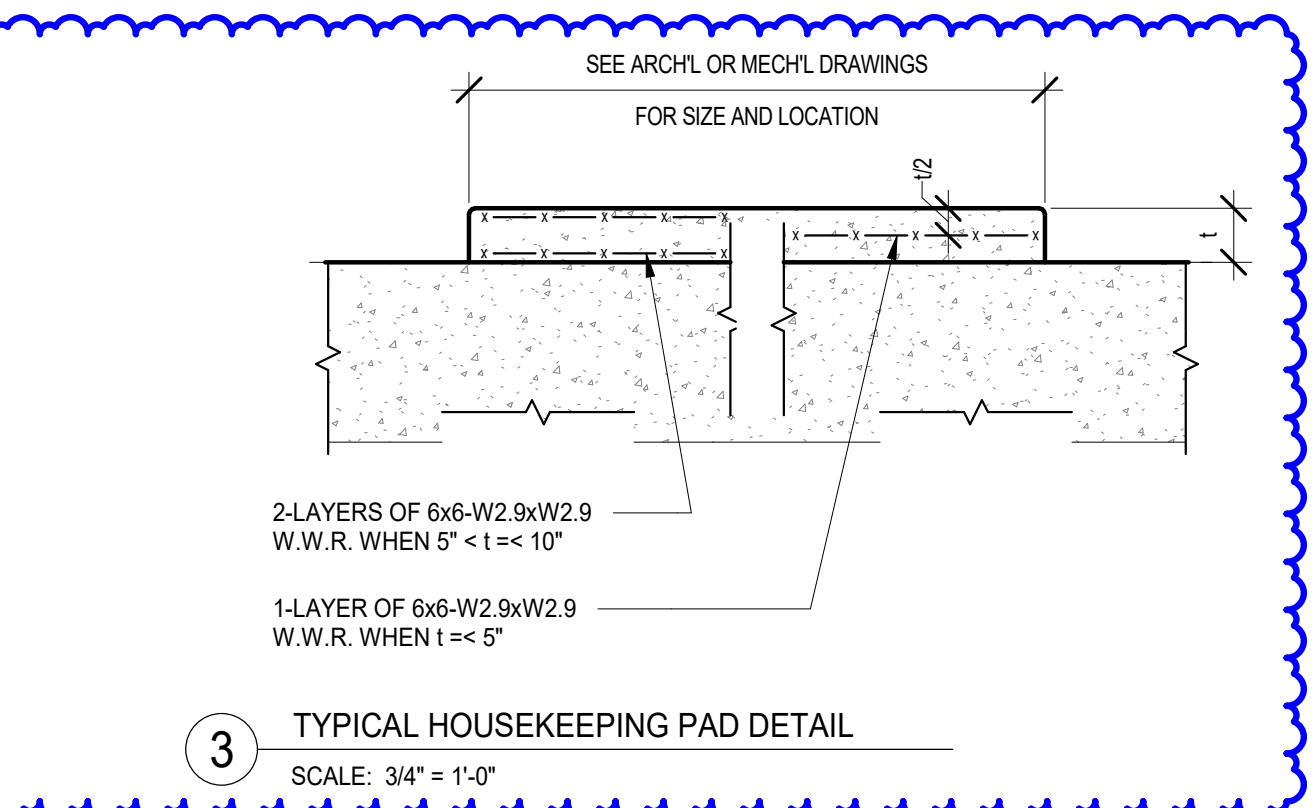
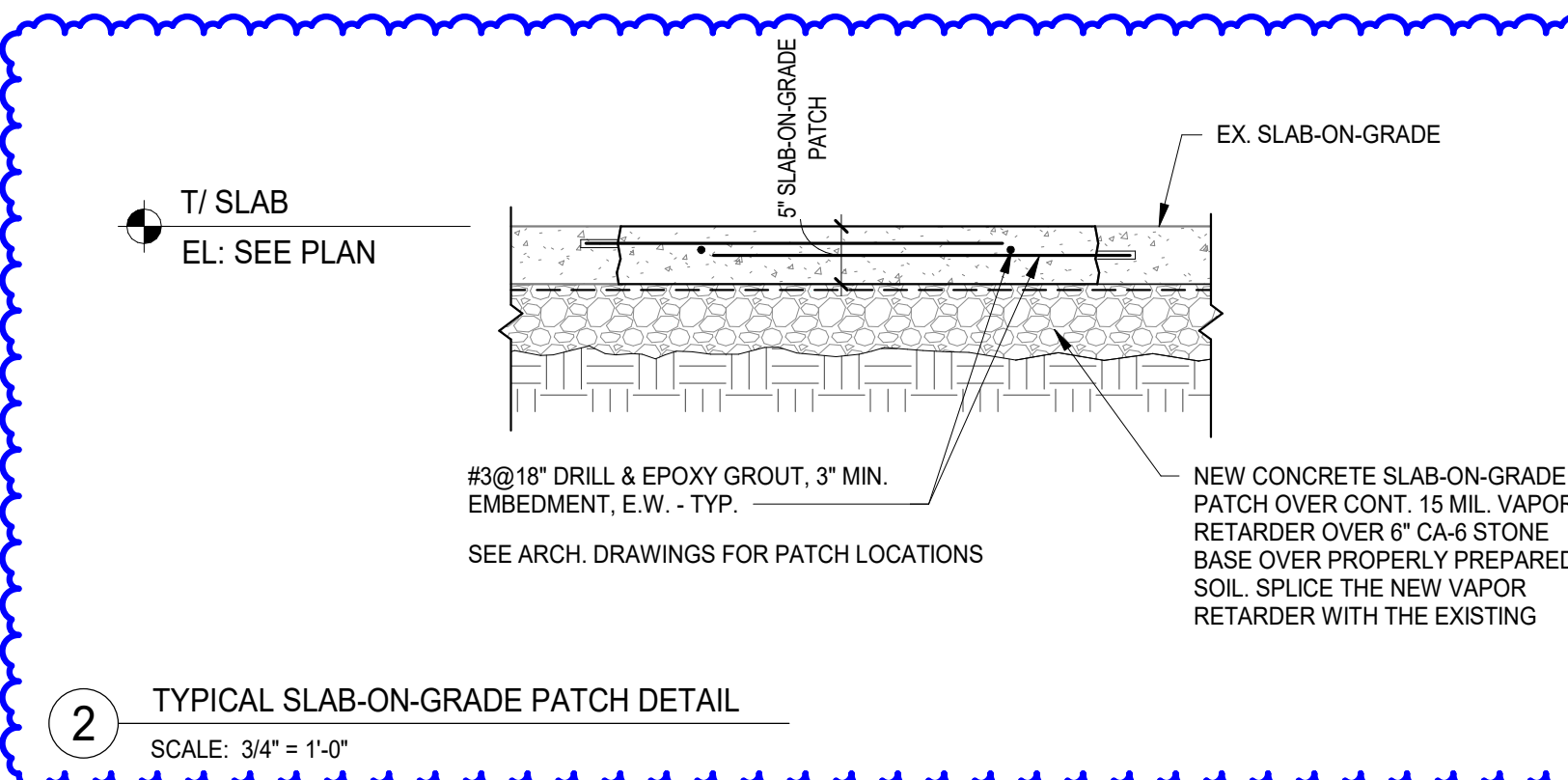
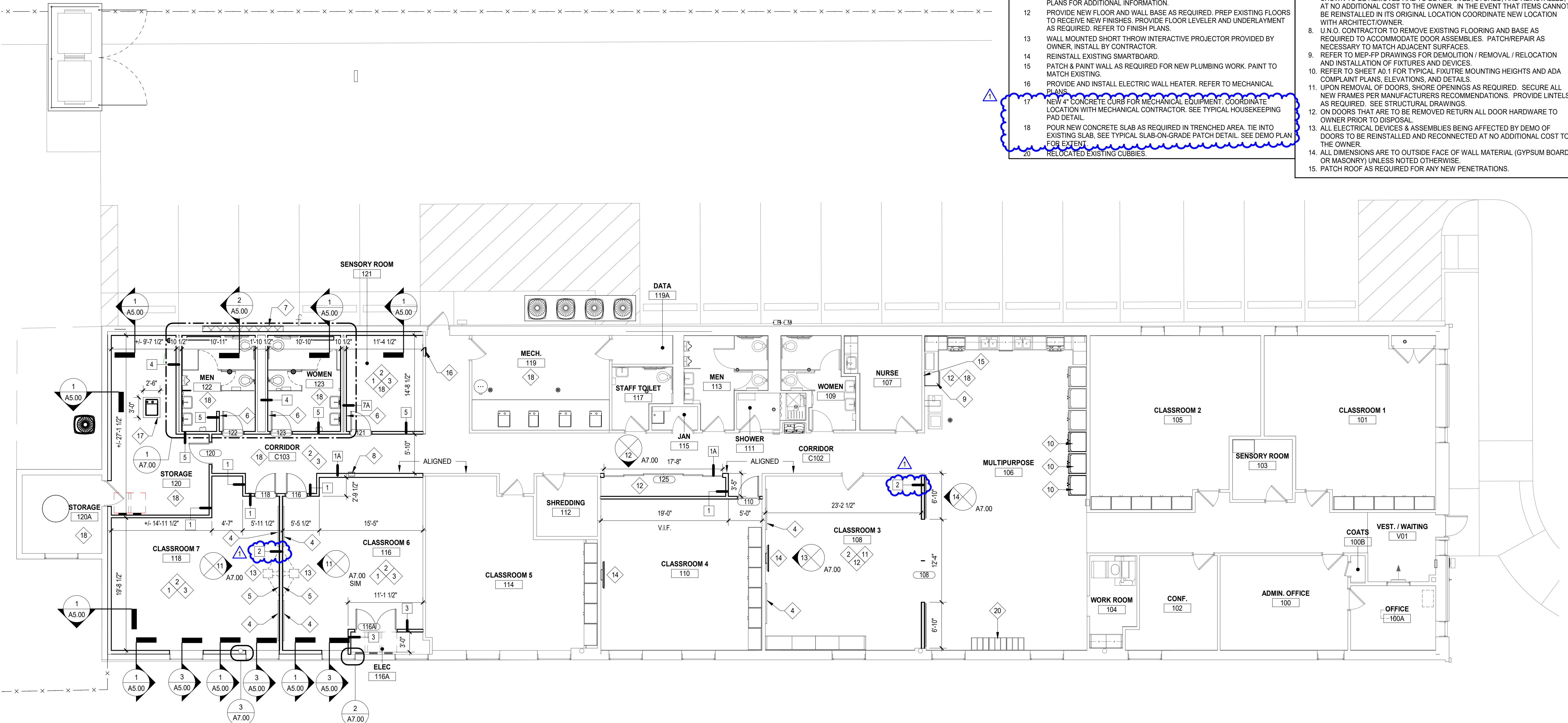

1 FIRST FLOOR PLAN
SCALE: 1/8" = 1'-0"

2/12/2021 9:17:16 AM C:\Users\jlsk\Documents\200191_199_ARCH_2019_Central_slaski.rvt Wight & Co. © Copyright 2016 All rights reserved. No part of these documents may be reproduced, stored, or transmitted in any form or by any means, electronic, mechanical, photocopying, recording or otherwise, without the prior written consent of Wight & Co.

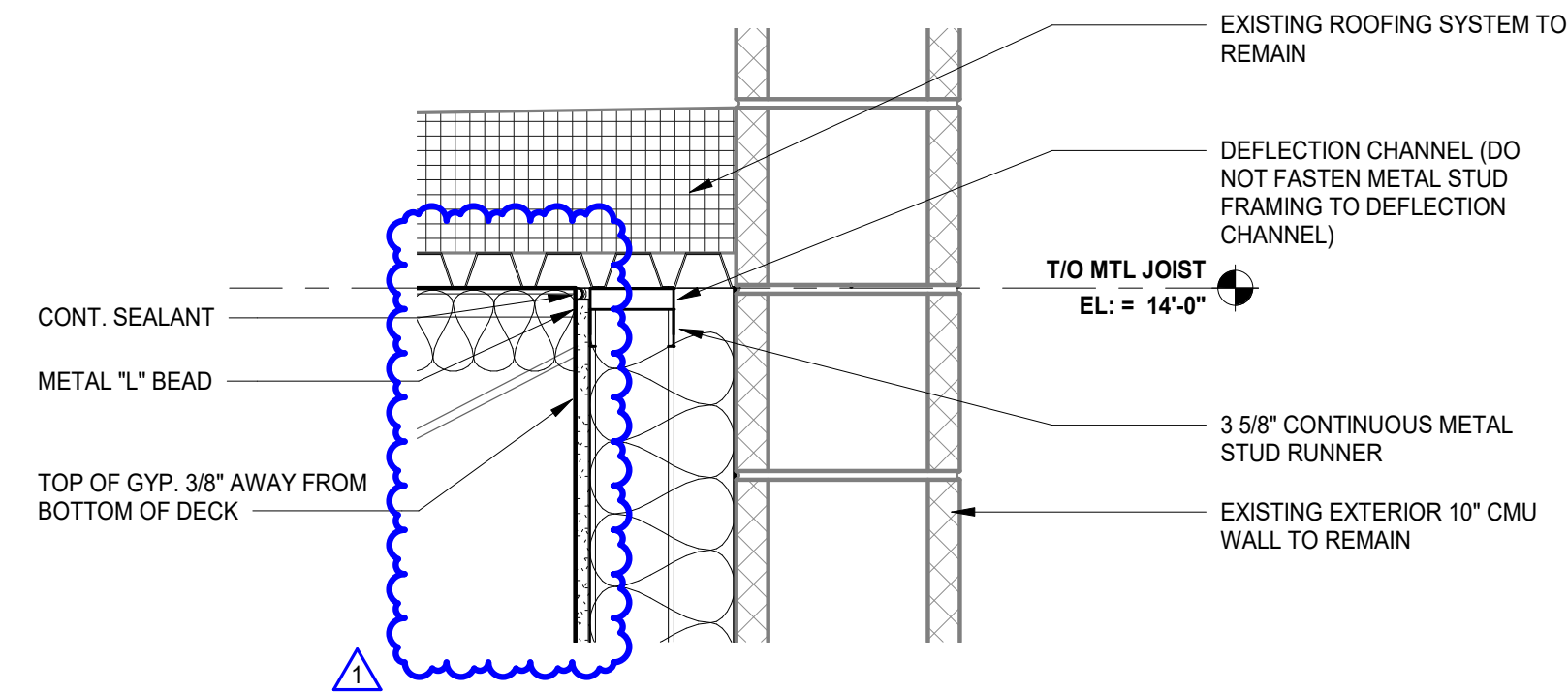

4 EXTERIOR WALL SECTION DETAIL, TYP.
SCALE: 1 1/2" = 1'-0"

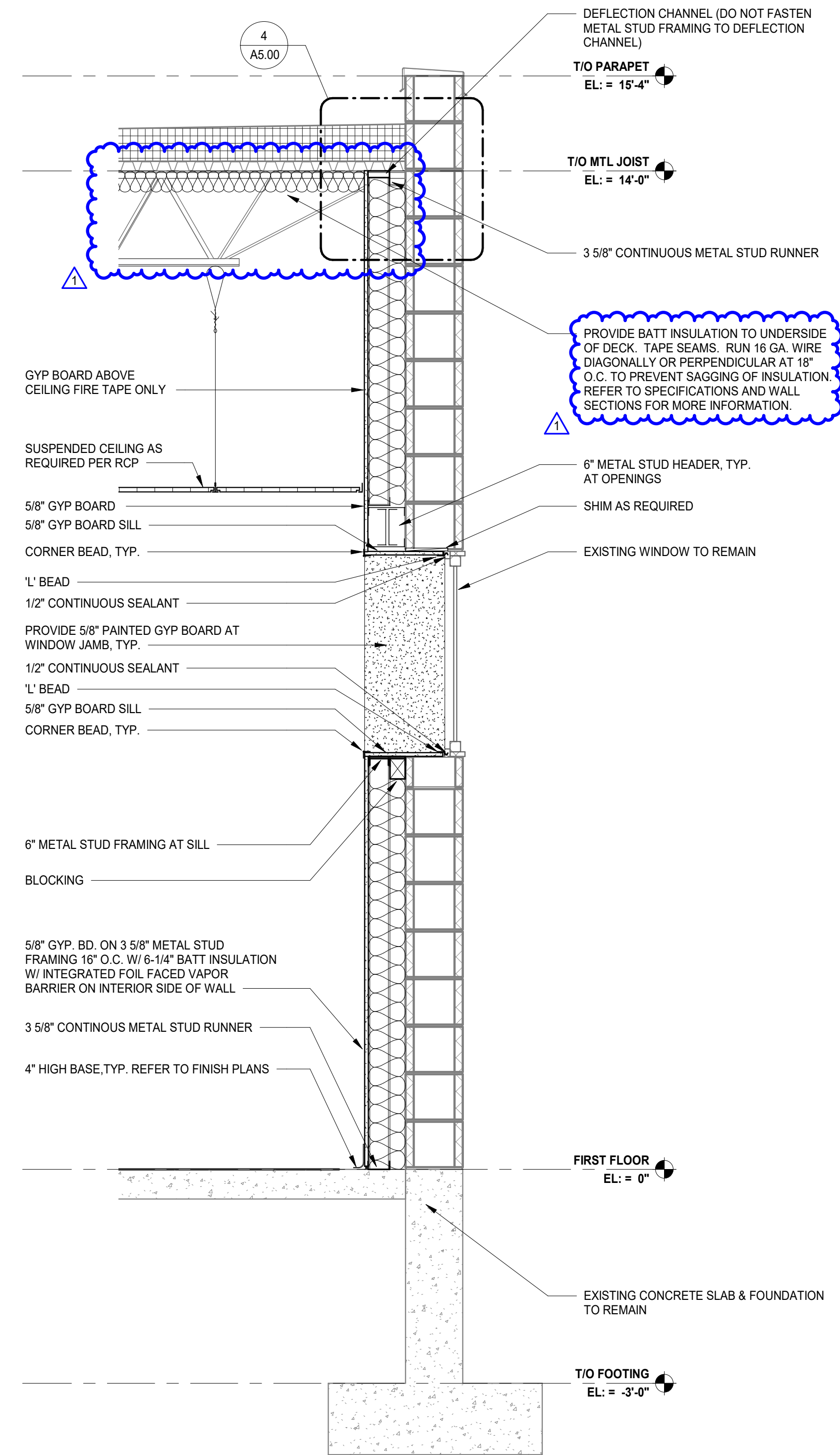

3 EXTERIOR WALL SECTION AT WINDOW OPENINGS
SCALE: 3/4\"/>

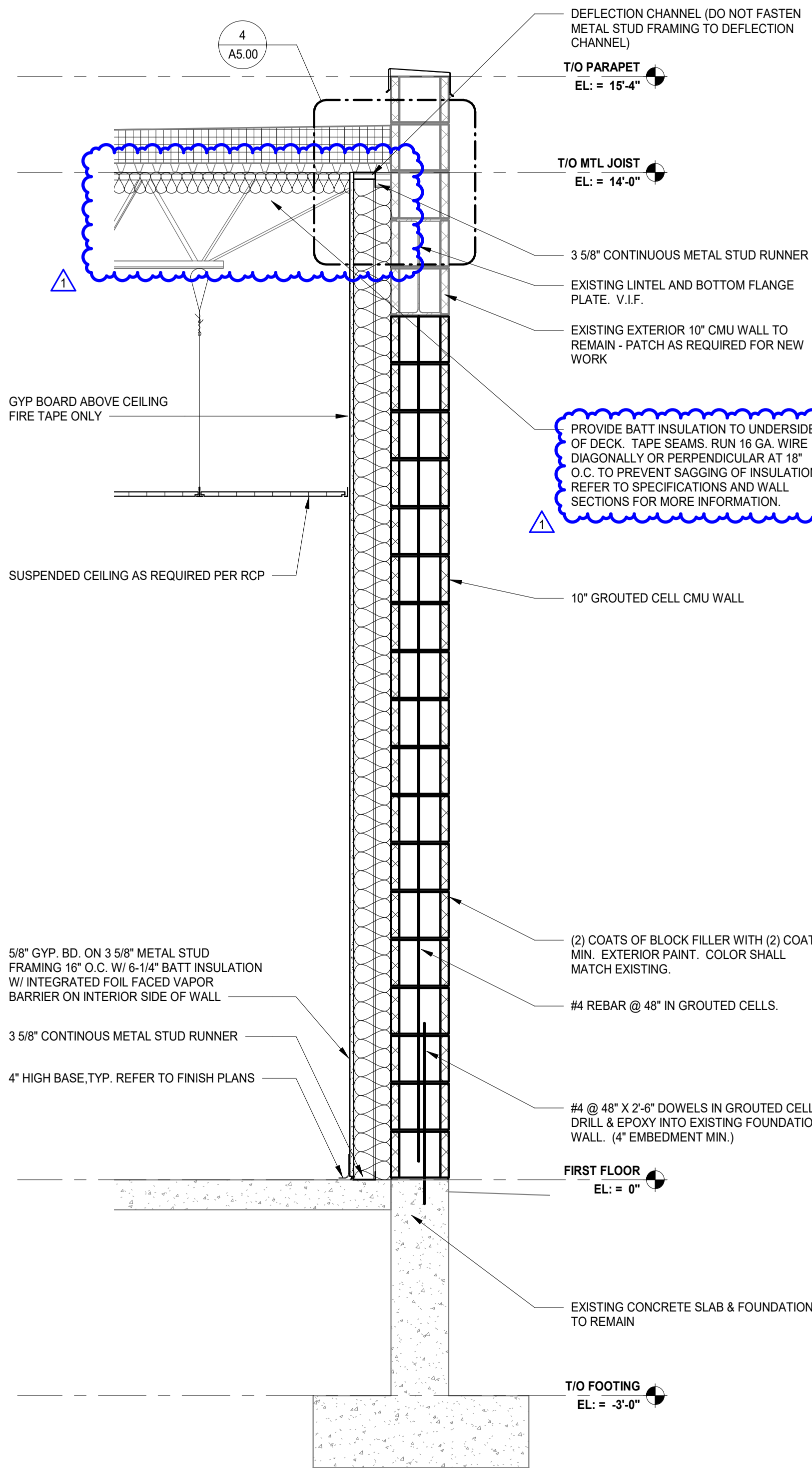

2 EXTERIOR WALL SECTION AT INFILL
SCALE: 3/4\"/>

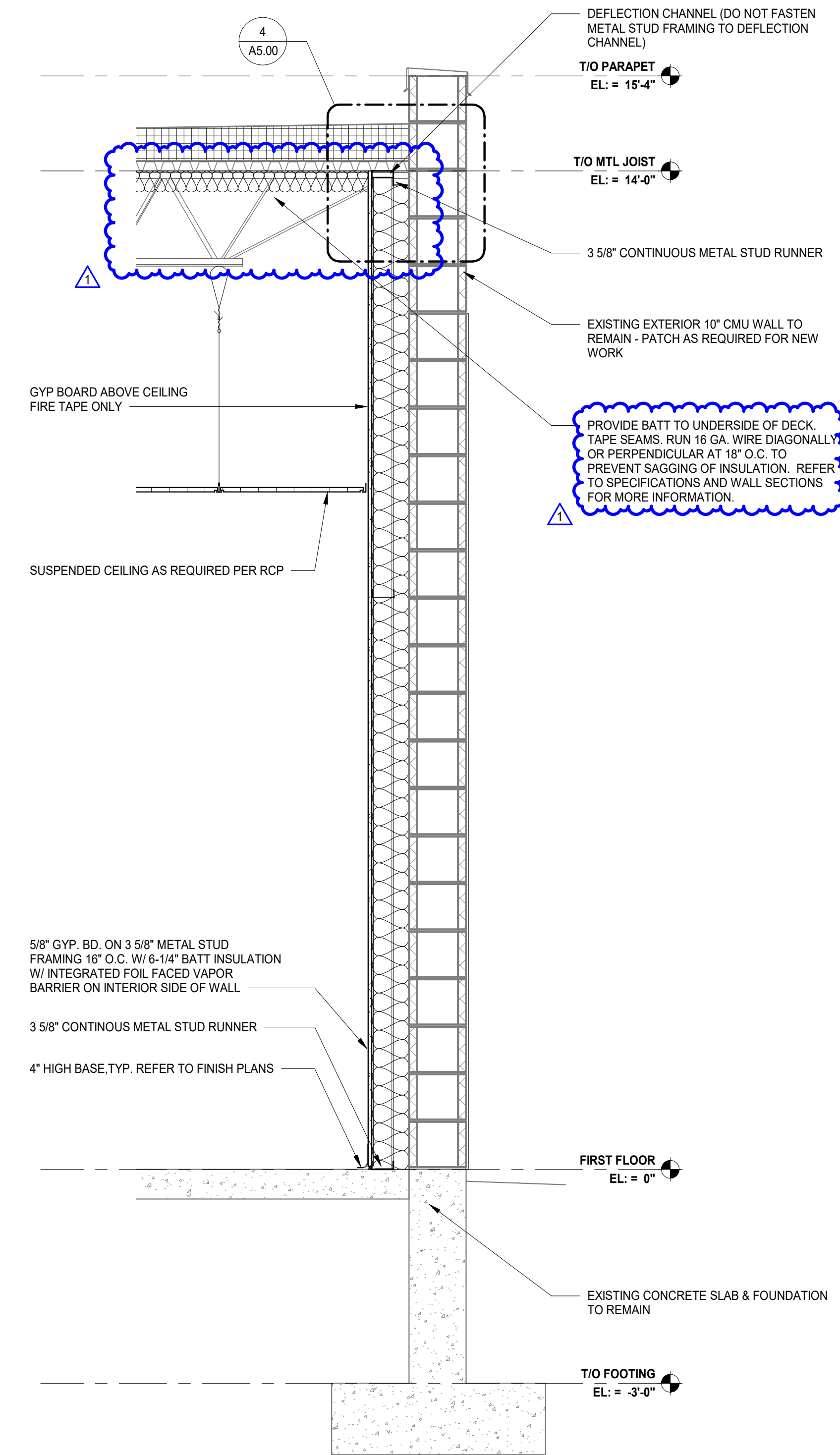

1 TYPICAL EXTERIOR WALL SECTION
SCALE: 3/4\"/>

2/11/2021 4:41:53 PM C:\Users\jlsaski\Documents\200191_199_ARCH_2019_Central_slaski.rvt Wight & Co. © Copyright 2016 All rights reserved. No part of these documents may be reproduced, stored, or transmitted in any form or by any means, electronic, mechanical, photocopying, recording or otherwise, without the prior written consent of Wight & Co.



COMMUNITY HIGH SCHOOL
DISTRICT 99



Wight & Company
wightco.com

2500 North Frontage Road
Darien, IL 60561

P 630.969.7000
F 630.969.7979

NOT FOR
CONSTRUCTION

1	ADDENDUM NO. 1	02/10/2021
	ISSUED FOR BID	01/15/2021
REV	DESCRIPTION	DATE

**TRANSITION BUILDING
BUILD-OUT**

4232 VENARD ROAD
DOWNERS GROVE, IL 60516

WALL SECTIONS

Project Number:
200191
Drawn By:
J. SLASKI
Sheet:

A5.00

2/11/2021 4:45:35 PM C:\Users\jlsaski\Documents\200191_199_ARCH_2019_Central_slaski.rvt Wight & Co. © Copyright 2016. All rights reserved. No part of these documents may be reproduced, stored, or transmitted in any form or by any means, electronic, mechanical, photocopying, recording or otherwise, without the prior written consent of Wight & Co.

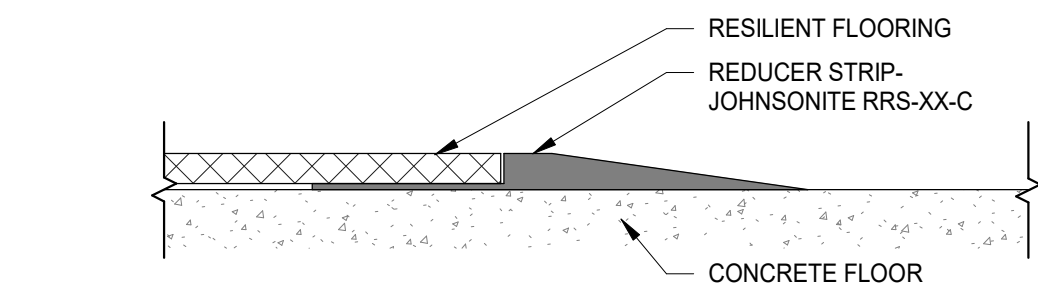

3 RESILIENT TO CONCRETE
SCALE: 3" = 1'-0"

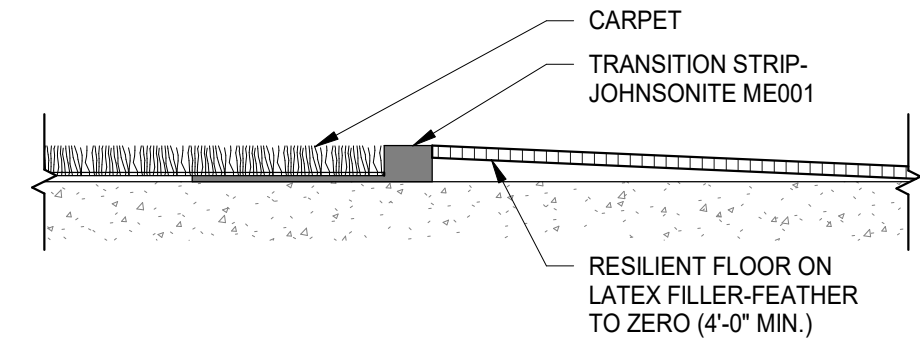

2 CARPET TO RESILIENT
SCALE: 3" = 1'-0"

SYMBOL	DESCRIPTION	MANUFACTURER	REMARKS
CONC	SEALED CONCRETE		PATCH & SEAL CONCRETE
CPT-1	CARPET TILE	TARKETT	STYLE: CRAYON COLOR: CRAYON 01957 - PRECIOUS METAL 48010 SIZE: - INSTALL: -
QTZ-1	OFF-WHITE QUARTZ TILE	PROCEDO FLOORING	STYLE: VERSA COLLECTION COLOR: FAIRBANKS QFAI SIZE: 24" x 24" INSTALL: QUARTER TURN
QTZ-2	TAN QUARTZ TILE	PROCEDO FLOORING	STYLE: VERSA COLLECTION COLOR: TUCSON QUTC SIZE: 24" x 24" INSTALL: QUARTER TURN
QTZ-3	GREEN QUARTZ TILE	PROCEDO FLOORING	STYLE: VERSA COLLECTION COLOR: - SIZE: 24" x 24" INSTALL: QUARTER TURN

SYMBOL	DESCRIPTION	MANUFACTURER	DESCRIPTION
PT-1	PAINT	SHERWIN WILLIAMS	COLOR: 6113 INTERACTIVE CREAM
PT-2	PAINT	SHERWIN WILLIAMS	COLOR: 6114 BAGEL
PT-3	PAINT	SHERWIN WILLIAMS	COLOR: 7748 GREEN EARTH
WT-1	WHITE SUBWAY CERAMIC WALL TILE	ROCA TILE USA	STYLE: COLOR COLLECTION COLOR: WHITE ICE BRIGHT U081 SIZE: 3" X 6" INSTALL: VERTICAL RUNNING BOND

SYMBOL	DESCRIPTION	MANUFACTURER	REMARKS
RB-1	4" COVE RUBBER BASE	ROPE	4" RUBBER BASE, COLOR: #140 FAWN

SYMBOL	DESCRIPTION	MANUFACTURER	REMARKS
PL-1	PLASTIC LAMINATE	WILSONART	COLOR: 7943K-07 WALNUT V.I.F. TO MATCH EXISTING
PL-2	PLASTIC LAMINATE	WILSONART	COLOR: 1787-60 OXIDE V.I.F. TO MATCH EXISTING

#	KEY NOTES
F1	NEW FLOORING TO MATCH EXISTING
F2	PAINT METAL VENT PIPE ENCLOSURE RISERS

- FINISH LEGEND GENERAL NOTES**
- NOTE:**
- SEE SHEET A10.00 FOR PROJECT MATERIALS, ADDITIONAL INFORMATION, AND DETAILS
- WALL**
- ALL WALLS TO RECEIVE PAINT FINISH TO FINISHED CEILING UNLESS NOTED OTHERWISE
 - WALL TILE TO CONTINUE BEHIND TOILET ROOM ACCESSORIES.
 - TOILET ROOM WALLS TO RECEIVE WALL TILE. SEE TOILET ROOM ELEVATIONS FOR EXACT LOCATIONS AND TYPES.
 - PAINT OF GYP. BD. PARTITIONS TO BE SEMI-GLOSS U.N.O. PAINT ON GYP. BD. CEILINGS TO BE FLAT U.N.O. PAINT ON CMU PARTITIONS TO BE SEMI-GLOSS U.N.O. PAINTED WOOD DOORS AND GRAMES TO BE SEMI-GLOSS U.N.O.
 - ALL WALLS TO BE PT-1 U.N.O.
 - PROVIDE EXTRUDED STAINLESS STEEL EASED 90 DEGREE PROFILE LIKE SCHLUTER JOLLY AT ALL OUTSIDE CORNERS AND EXPOSED EDGES IN WALL TILE. PROFILE TO BE BRUSHED STAINLESS STEEL FINISH.
 - NO PAINT FINISH ON BRICK PARTITIONS/SOFFITS U.N.O.
 - PROVIDE GROUTED CORNER AT ALL WALL TILE INSIDE CORNERS.
- BASE**
- ALL PAINTED CMU PARTITIONS TO RECEIVE 4" H RESILIENT BASE U.N.O. STRAIGHT PROFILE BASE TO BE USED AT CARPET FLOOR SURFACES U.N.O. COVE PROFILE BASE TO BE USED AT ALL OTHER FLOOR SURFACES U.N.O.
 - RESILIENT BASE TO OCCUR ON CASEWORK U.N.O.
 - TB-1 AND TB-2 TO BE PRODUCED ON SITE BY FIELD CUTTING FLOOR TILE TO 3" HEIGHTS. PROVIDE EXTRUDED STAINLESS STEEL EASED 90 DEGREE PROFILES LIKE SCHLUTER JOLLY AT EXPOSED CUT EDGE AT TOP OF TILE BASE.
 - PROVIDE GROUTED CORNER AT ALL WALL TILE TO FLOOR TILE INSIDE CORNERS.
- FLOOR**
- FOR FLOOR TRANSITION DETAILS REFER TO A10.00.
 - ALL FLOORING MATERIAL CHANGES TO OCCUR AT CENTER OF DOOR SIDE STOP. REFER TO A10.00.
 - FLOORING EXTENDS UNDER CABINETRY U.N.O.
 - CARPET TILE ORIENTATION AS NOTED ON DRAWINGS.
- MISCELLANEOUS**
- INTERIOR HOLLOW METAL DOOR AND FRAME TO BE PAINTED PT-1 U.N.O.
 - INTERIOR HOLLOW METAL FRAMES TO BE PAINTED PT-1 U.N.O.
 - SEE CASEWORK ELEVATIONS AND DETAILS FOR FINISH MATERIALS OF CASEWORK AND CUSTOM ARCHITECTURAL WOODWORK.
 - ALL MISC. METAL TO BE PAINTED PT-1 U.N.O.
 - WALL AND CEILING CONTROL JOINTS TO BE PAINTED TO MATCH ADJACENT WALL COLOR U.N.O.
 - REVEALS IN WALLS TO BE BRUSHED ALUMINUM, NO PAINT.
 - STAIR STRINGERS, GUARDRAILS, AND HANDRAILS TO BE PAINTED PT-1.

- FLOOR TRANSITIONS GENERAL NOTES**
- REFER TO SPECIFICATIONS FOR MATERIAL AND BASIS-OF-DESIGN PRODUCTS U.N.O.
 - COORDINATE TRANSITIONS WITH ACTUAL FLOORING TO BE INSTALLED.

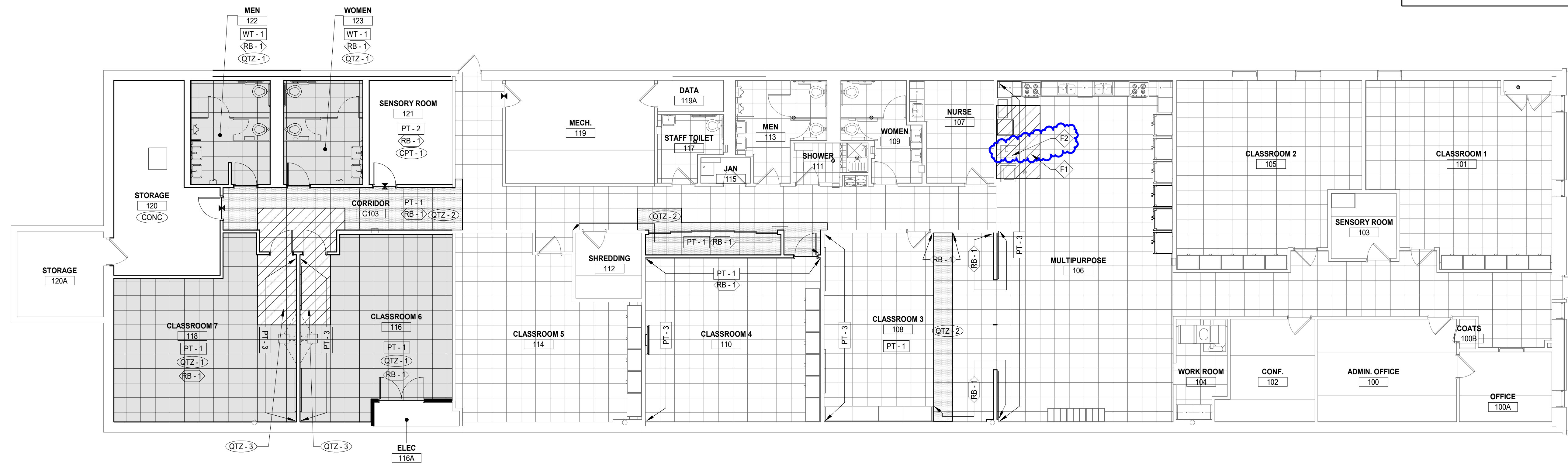

1 FIRST FLOOR FINISH FLOOR PLAN
SCALE: 1/8" = 1'-0"



COMMUNITY HIGH SCHOOL
DISTRICT 99



Wight & Company
wightco.com
2500 North Frontage Road
Darien, IL 60561
P 630.969.7000
F 630.969.7979

NOT FOR
CONSTRUCTION

REV	DESCRIPTION	DATE
1	ADDENDUM NO. 1	02/10/2021
	ISSUED FOR BID	01/15/2021

**TRANSITION BUILDING
BUILD-OUT**

4232 VENARD ROAD
DOWNERS GROVE, IL 60516

**FINISH PLAN,
SCHEDULES & GENERAL
NOTES**

Project Number:
200191
Drawn By:
J. SLASKI
Sheet:

A10.00

2/11/2021 4:08:20 PM C:\Users\pall\Documents\200191_T99_MEP-FP_2019_Cemal_rjpal.rvt Wight & Co. © Copyright 2016. All rights reserved. No part of these documents may be reproduced, stored, or transmitted in any form or by any means, electronic, mechanical, photocopying, recording or otherwise, without the prior written consent of Wight & Co.

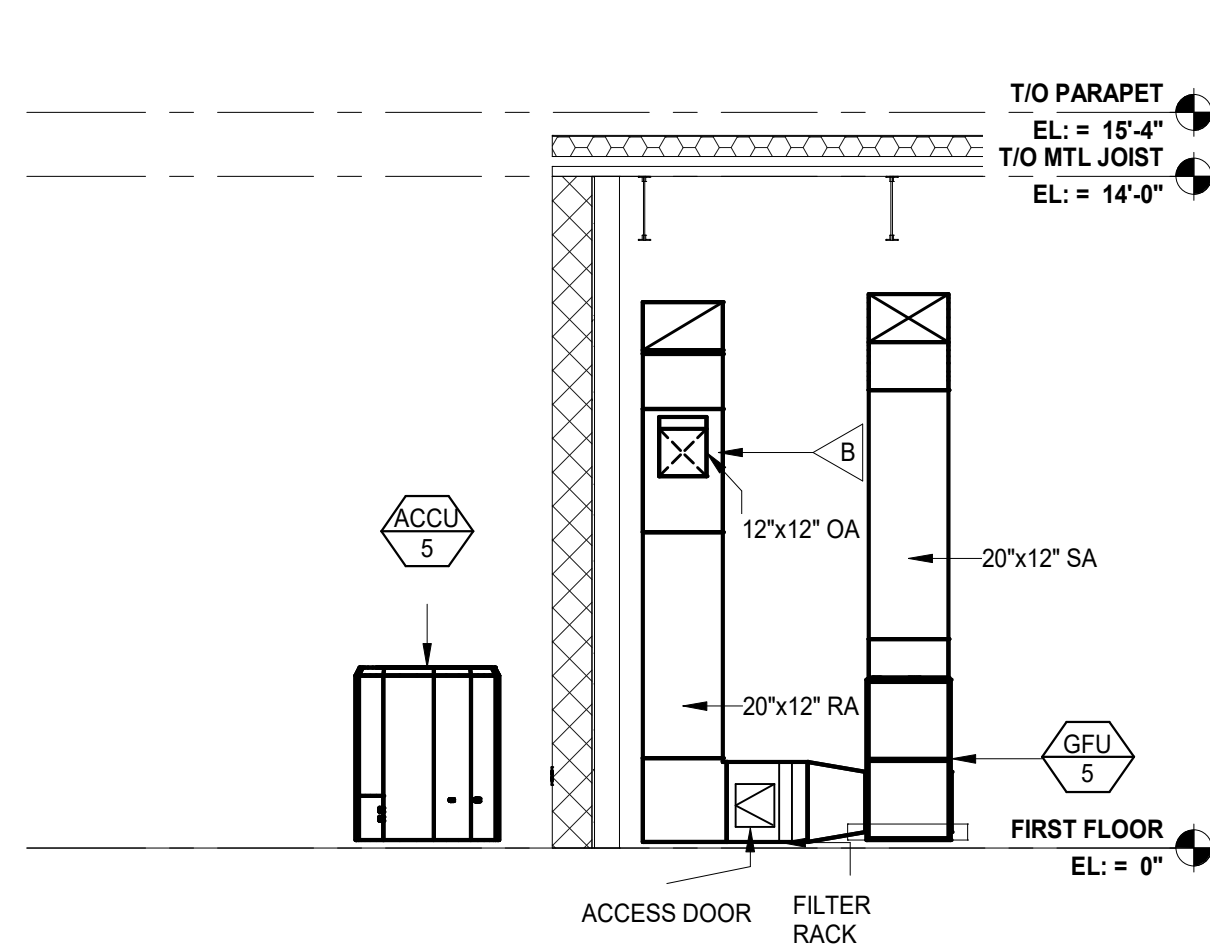

2 Section 2
SCALE: 1/4" = 1'-0"

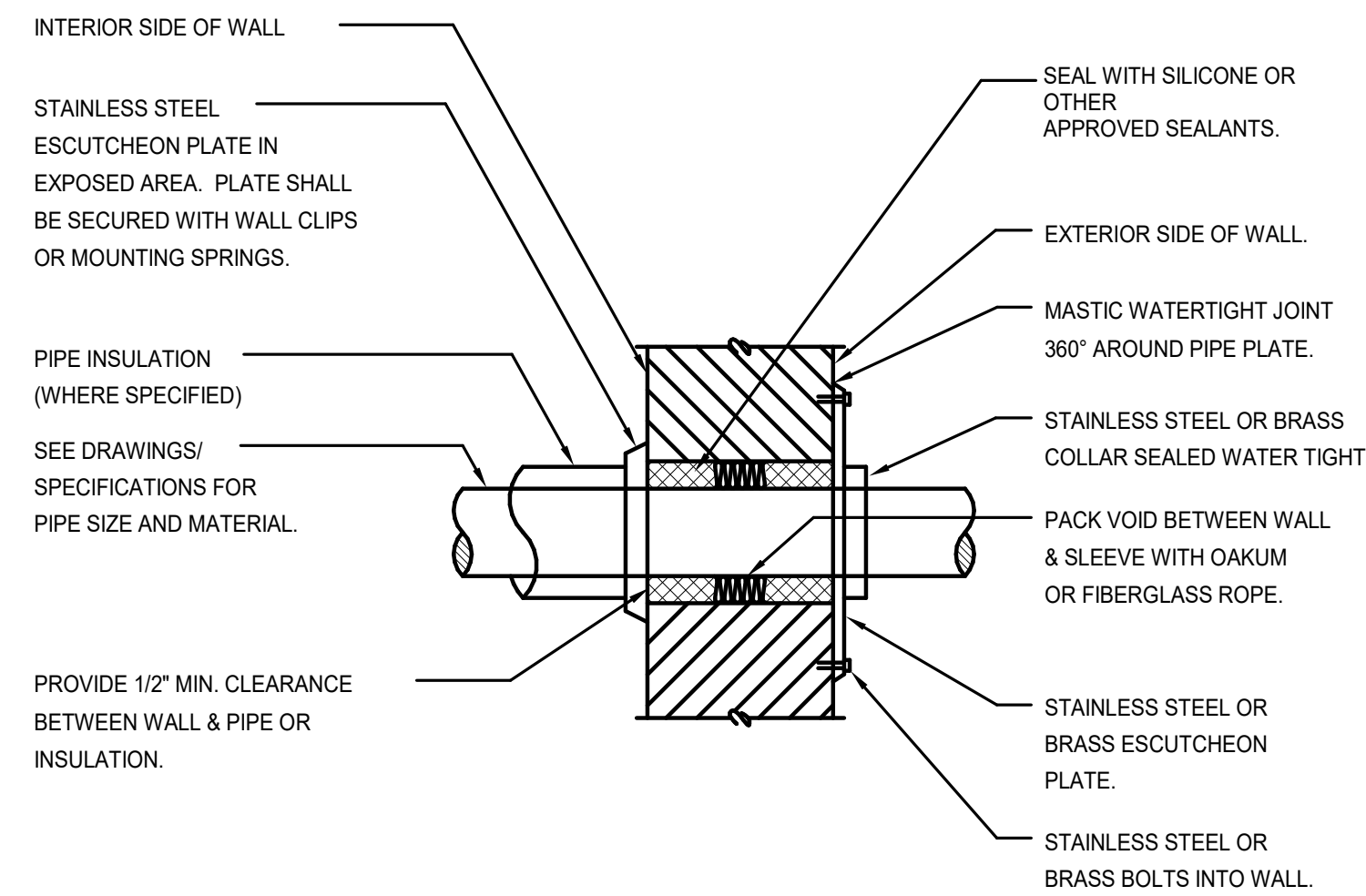

- NOTES:
1. CONTRACTOR SHALL ISOLATE ALL PIPES WHICH VIBRATE FROM CONSTRUCTION IN ORDER TO AVOID TRANSMISSION TO STRUCTURE.
 2. CONTRACTOR SHALL BE RESPONSIBLE FOR THE COORDINATION OF THEIR WALL OPENINGS WITH OTHER TRADES AND/OR CONTRACTORS.

3 PIPE PENETRATION OF EXTERIOR WALL ABOVE GRADE
SCALE: 12" = 1'-0"

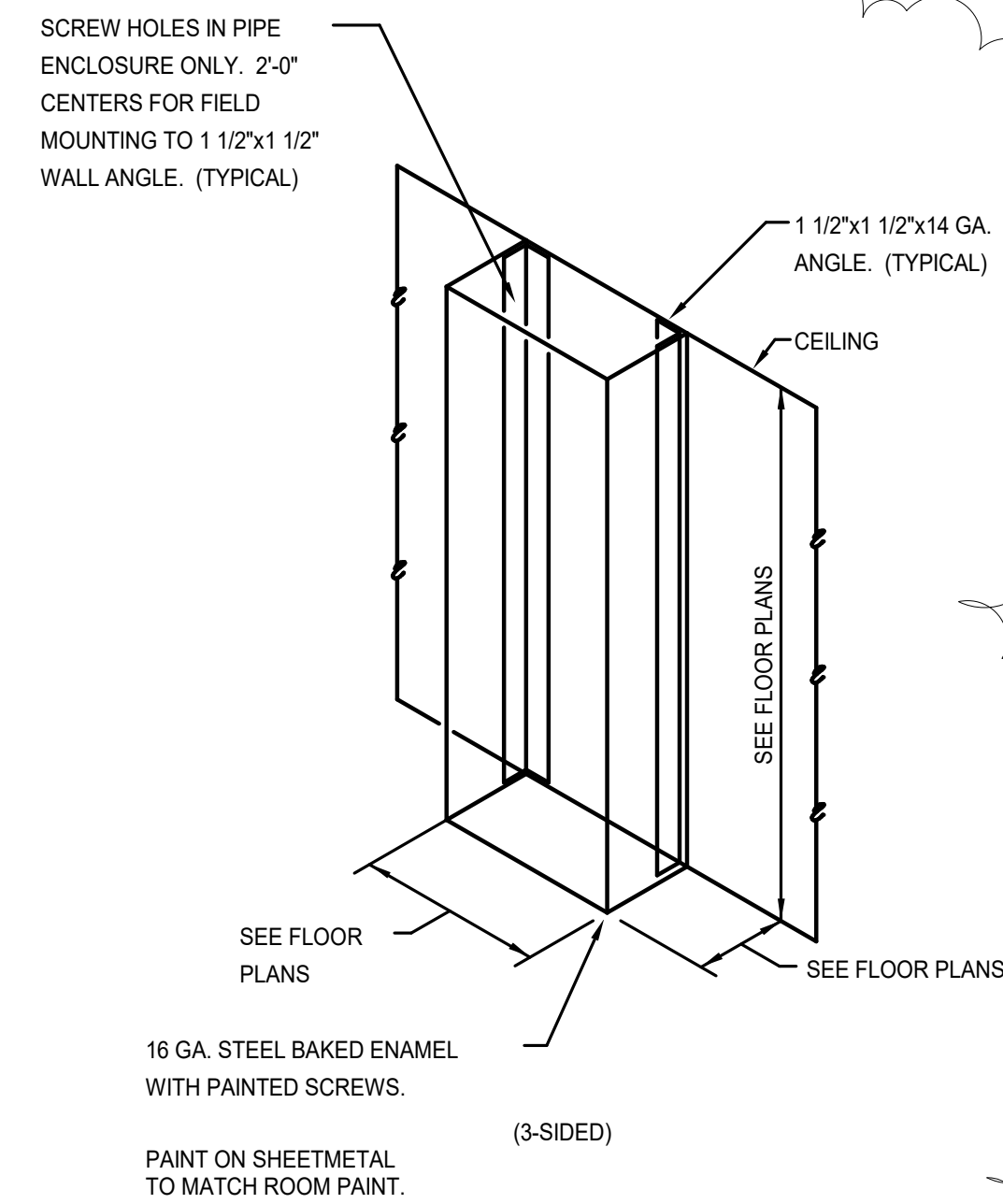

4 PIPE ENCLOSURE
SCALE: 12" = 1'-0"

- # KEY NOTES
1. PROVIDE AND INSTALL NEW GAS FIRED FURNACE TO SERVE THE NEW ADDITION. INSTALL GAS FIRED FURNACE ON NEW 4" HIGH CONCRETE PAD. PROVIDE VIBRATION ISOLATORS PER MANUFACTURER'S RECOMMENDATIONS.
 2. PROVIDE AND INSTALL OUTDOOR AIRCOOLED CONDENSING UNIT TO SERVE THE GAS FURNACE. INSTALL CONDENSING UNIT ON NEW 4" HIGH CONCRETE PAD.
 3. INTAKE AIR BOOSTER FAN TO BE INSTALLED INLINE WITH THE OUTDOOR AIR DUCTWORK.
 4. ELECTRIC DUCT HEATER TO RAISE THE TEMPERATURE OF AIR FROM -10 TO 40 DEG F.
 5. RELOCATE EXISTING GAS FIRED UNIT HEATER AS SHOWN. RE-INSTALL NEW VENT TO ROOF. RE-INSTALL EXISTING TEMPERATURE SENSOR TO LOCATION SHOWN.
 6. PROVIDE NEW WALL LOUVER WITH BIRDSCREEN AND MANUAL DAMPER FOR OUTSIDE AIR INTAKE.
 7. OUTSIDE AIR DUCT TO CONNECT TO RETURN AIR DUCT. PROVIDE MANUAL DAMPER FOR BALANCING PURPOSES.
 8. DUCTED RETURN TO BE ROUTED AS SHOWN.
 9. EXHAUST GRILLES TO BE CONNECTED VIA EXHAUST DUCTWORK TO ROOF MOUNTED EXHAUST FANS.
 10. REBALANCE EXISTING DIFFUSERS TO 120 CFM EACH.
 11. REBALANCE EXISTING DIFFUSERS TO 240 CFM EACH.
 12. PROVIDE NEW TRANSFER DUCT AND GRILLE.
 13. PROVIDE NEW ELECTRIC WALL HEATER AS SHOWN.
 14. PROVIDE MOTORIZED DAMPER IN THE FRESH AIR INTAKE DUCT. PROVIDE 120V ACTUATOR. THE OPERATION OF THE DAMPER TO BE TIED TO THE OPERATION OF THE GAS FURNACE. WHEN THE FURNACE IS ON, THE DAMPER OPENS TO ITS SET POSITION AND WHEN THE FURNACE IS OFF, THE DAMPER CLOSES.
 15. PROVIDE FIRE DAMPERS IN SUPPLY AND RETURN DUCT AS SHOWN.
 16. PROVIDE DUCT MOUNTED ELECTRIC COIL IN THE DUCT SERVING THE SENSORY ROOM. INSTALL WALL MOUNTED THERMOSTAT AS SHOWN.
 17. PROVIDE FINNED TUBE RADIATORS AS SHOWN TO SERVE THE RESTROOMS. REFER TO ELEVATION VIEW ON THIS SHEET FOR MORE DETAILS.
 18. EXISTING DRYER VENTS TO A "BOX". DEMOLISH THE BOX AND ROUTE NEW DRYER VENT TO THE EXTERIOR WALL FOLLOW MAX. LENGTH RECOMMENDATION BY MANUFACTURER. PROVIDE DRYER VENT CAP WITH BACKDRAFT DAMPER AND TERMINATE PER MANUFACTURER'S INSTRUCTIONS. SEAL AND CAULK AROUND OPENING FOR A LEAK PROOF JOINT. REFER TO DETAILS ON THIS SHEET FOR DUCT/PIPE PENETRATING AN EXTERIOR WALL AND ALSO FOR PROVISION OF A SHEET METAL ENCLOSURE TO COVER THE EXPOSED DRYER VENT DUCT.
 - 19.

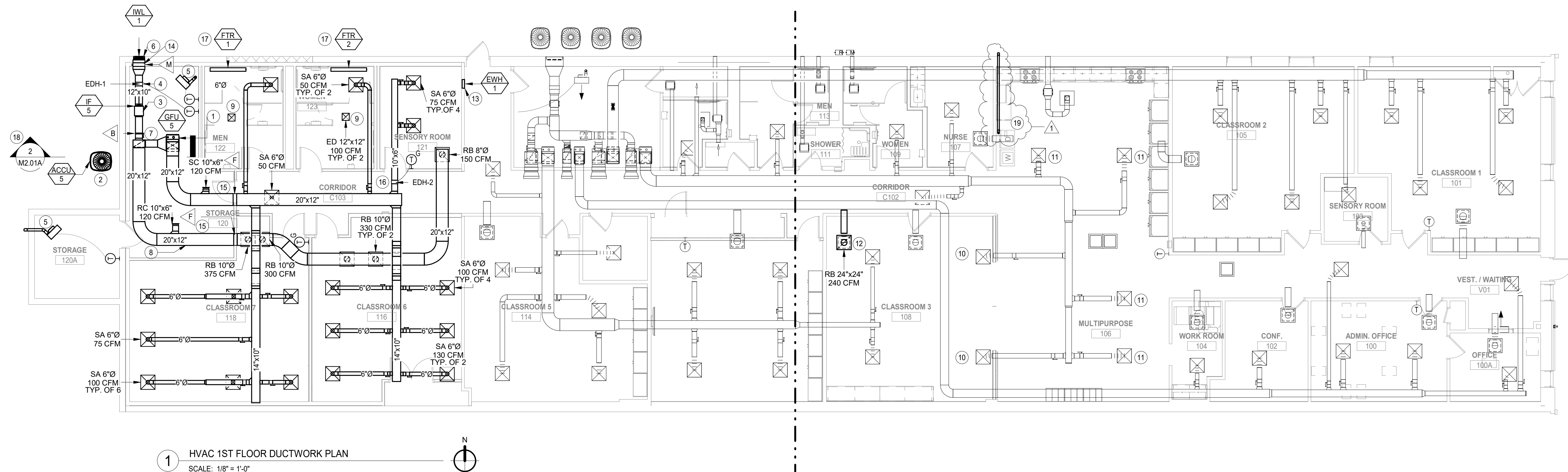

1 HVAC 1ST FLOOR DUCTWORK PLAN
SCALE: 1/8" = 1'-0"



COMMUNITY HIGH SCHOOL
DISTRICT 99



Wight & Company
wightco.com
2500 North Frontage Road
Darien, IL 60561
P 630.969.7000
F 630.969.7979

NOT FOR CONSTRUCTION

REV	DESCRIPTION	DATE
1	ISSUED FOR ADDENDUM 1	02/12/2021
	ISSUED FOR BID	01/15/2021
	ISSUED FOR 75% CD	12/30/2020
	ISSUED FOR 100% DD	12/09/2020

**TRANSITION BUILDING
BUILD-OUT**

4232 VENARD ROAD
DOWNERS GROVE, IL 60516

**HVAC FIRST FLOOR NEW
DUCTWORK PLAN**

Project Number:
200191
Drawn By:
Author
Sheet:

M2.01A